

Design Guide

Self-regulating trace heating systems for hazardous / industrial applications



Design guide

BARTEC Self-regulating trace heating systems
for pipes and tanks in hazardous locations
with BARTEC self-regulating trace heating cables PSB and MSB

Origin Design Guide

Table of content

Design Guide	1	Installation self-regulating trace heaters on pipes and vessels	30
Self-regulating trace heating systems for hazardous / industrial applications	1	Preparation	30
Overview	2	Required tools / equipment	30
Applications	3	Unrolling the trace heater	30
Certifications / Approvals / Marking	3	Installation on pipes	30
Safety	3	Fastening	31
Intended use	3	Trace heater routing	31
Specific Conditions of Use	4	Installation on tanks and vessels	33
Foreseeable Misuse	4	Tests and commissioning	36
Personal Qualification	4	Measurement of the insulation resistance	36
Applicability	5	Acceptance test and acceptance test report	37
Technical data	6	Commissioning	37
Self-regulating trace heating system	6	Operation	37
Trace heater	6	System documentation	37
Trace heater Installation Enclosure as <i>Power Box</i> kit	7	Maintenance	38
Trace heater Installation Enclosure as <i>End of Line Light</i> kit and <i>End of Line Seal</i> kit	8	Visual and functional inspection	38
System design	9	Electrical inspection	38
Trace heater selection	9	Inspection intervals	38
Determination of the required trace heater length	16	Personnel training courses	38
Determination of the required number of heating circuits	17	Repairwork on piping or thermal insulation	38
Selection of the required components for power connection, control and monitoring, end termination etc.	19	Disposal and Recycling	38
Trace heaters	25	Disposal	38
Power connection, splice and junction components	26	The appliance must be disposed of in accordance with local laws and regulations according to its components.	38
Control and monitoring units	27	Checklist customized entry port	39
End termination	28	Acceptance report / Record of inspection	40
Spare parts	29	Troubleshooting	41
		Limited Product warranty (Worldwide, excepting North America)	42

Overview

This manual covers the design and general installation of BARTEC Self-regulating trace heating systems for use in hazardous locations using the following self-regulating heating cables, hereinafter called trace heaters:

- BARTEC PSB (07-5853-*)
- BARTEC MSB (07-5854-*)

A trace heater unit comprises the power termination, a trace heater and an end termination. The trace heater unit can be made of a single trace heater or multiple trace heaters connected by a splice or for a tee which are pre-determined by BARTEC.

The trace heating system consists of one or more trace heater units grouped by a common power termination; the junction box is pre-determined by BARTEC as Installation Enclosure for trace heating. Each trace heating system is associated with design and installation documentation.

One or more trace heating systems can be merged by a common branch circuit to a heating circuit group with a joint over current device. Optional components for temperature control or limitation and for annunciation can be included in the trace heating system. Besides the components the system consists of rules for design and installation and it's documentation.

The self-regulating trace heater features a temperature-dependent resistive element between two parallel copper conductors that regulates and limits the heat output of the trace heater according to the workpiece temperature. If the workpiece temperature rises, the power output of the trace heater is reduced. This self-regulating property prevents overheating which would cause damage to the trace heater. Even crossing or overlapping with other trace heaters (or other portions of the same trace heater) are possible.

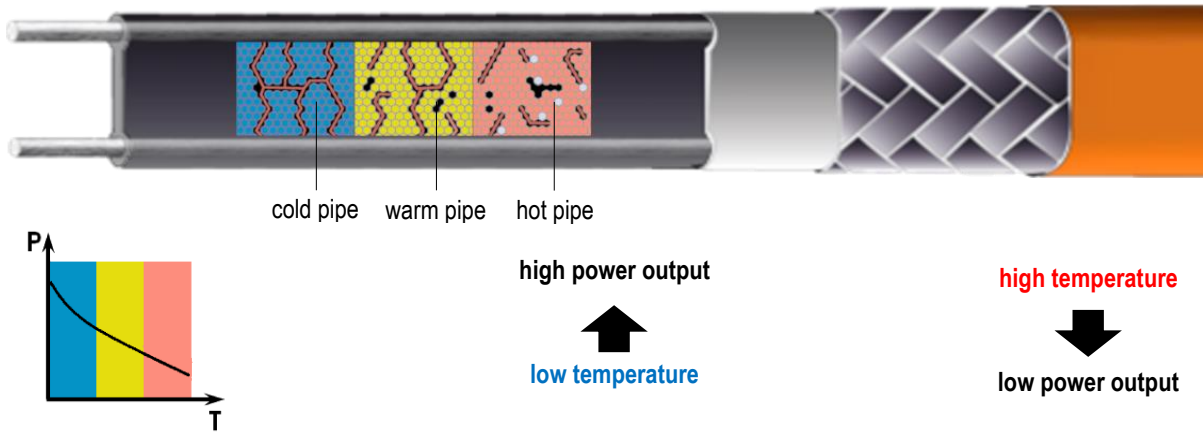

The trace heaters are fixed equipment heating systems for pipes in ordinary and hazardous areas. Thanks to the parallel design the trace heater can be cut and installed to any required length (up to the maximum heating circuit length as shown on page 18).

Multiple options for connection, splicing and end termination of the heating circuit are available to meet the individual requirements on site. A large variety of accessories allows for easy customization and extensibility. The following illustration shows a typical electric trace heating system:

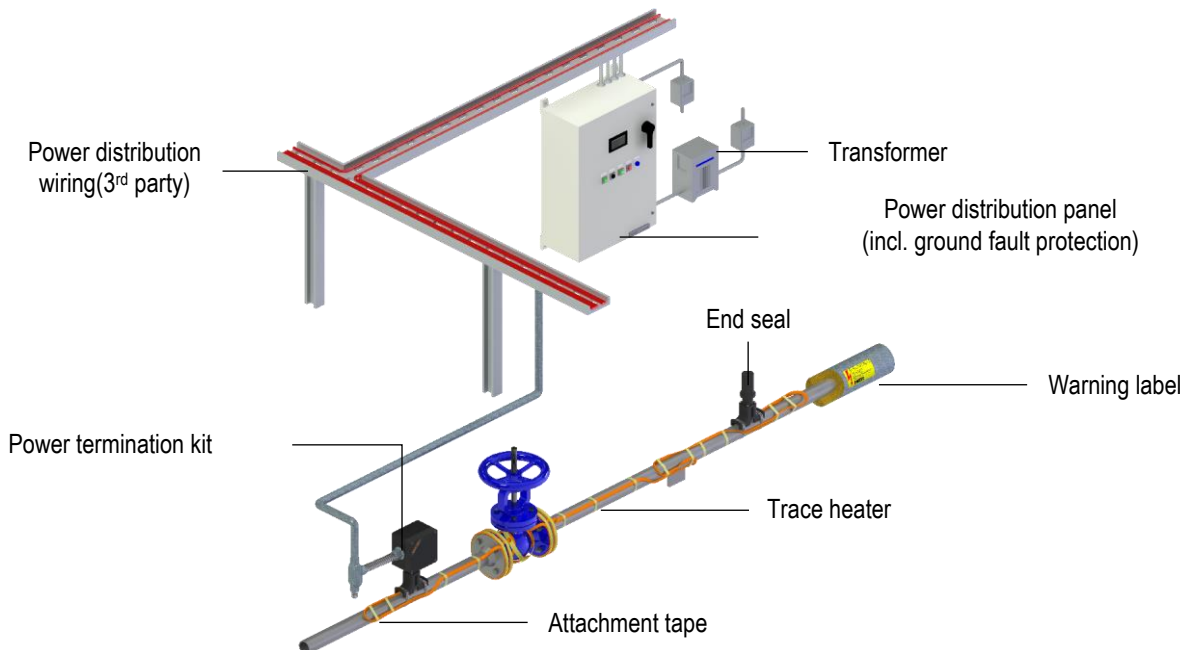

Applications

Trace heating compensates for the heat loss through the insulation to maintain the pipe and fluid at temperatures above the freezing or solidification point. Thus, trace heating is critical for pipe freeze protection systems that are expected to have stagnant fluids for prolonged durations.

Freeze protection:

Water, and fluids containing significant water, expand as they freeze. This expansion can cause the pipe to be blocked or break leading to:

- Economic losses: A frozen water pipe leading to a critical process like a frozen pipe in a waste water treatment plant or cooling tower can shut down the operation causing high economic losses.
- Safety issues: A frozen pipe to safety showers can jeopardize personnel safety in the event of hazardous chemical exposure.

Temperature maintenance:

A process temperature maintenance system can maintain the temperature of the fluid in a pipe to the desired level over a broad range of temperatures.

Maintaining liquids within the specified temperature range allows you to cost-effectively transport the fluids from one location to another, operate your processes at maximum efficiencies, and safely start/shut down your operations.

Certifications / Approvals / Marking



PSB/MSB DEKRA 20ATEX0093 X
IECEX DEK 20.0055X

BARTEC Self regulating trace heating systems with BARTEC PSB or MSB trace heaters

Safety

⚠ WARNING

Risk of fire or electrical shock. Follow these guidelines to avoid personal injury or material damage.

⚠ WARNING

Risk of fire or electrical shock due to electric trace heating system.
Risk of bursting of the cable gland.
At temperatures below -40°C, make sure that no mechanical shock of $x > 4$ joule is applied to the cable gland type Wiska ESKE/1 25 LT.
Protect the cable gland from mechanical shock.

⚠ CAUTION

Danger of burning due to electric heating system
Danger of burning from hot surface
Disconnect the heating circuit from the power supply before removing the pipe insulation. Allow the heating system to cool down.
Disconnect the heating circuit from the power supply before working on the enclosure. Allow the enclosure to cool down.

⚠ WARNING

Risk of fire or electrical shock due to electric trace heating system.
Risk of lost explosion protection.

After opening the enclosure, check that the enclosure sealing is in good condition. Ensure that the enclosure sealing is elastic and free of cracks. If the enclosure sealing is damaged, contact BARTEC GmbH.

⚠ CAUTION

The trace heating system is only applicable in case of workpiece temperature is higher than the layout ambient temperature.

For safe installation and operation of BARTEC Self-regulating trace heating systems the technical requirements and instructions given in this Design Guide, all applicable documents and the corresponding manuals of the installed products or products to be use must be followed. Keep these instructions for future reference. If applicable, leave them with the end user. Retain the trace heating system documentation for each trace heating circuit as long as the system is in use.

All electrical systems and installations must comply with BARTEC GmbH requirements and be installed in accordance with the relevant electrical codes and any other applicable national and local codes.

Use BARTEC Self-regulating trace heating cables in accordance with the intended use and strictly comply with the operational data specified in section Technical Data. Install all components of the trace heating system carefully.

Any defective component of the trace heating system must be replaced before installation. Replace each defect component of the trace heating system.

Use only original BARTEC accessories and spare parts.

Note that the Applicable Documents listed below shows further important information and must be observed in addition to this manual.

Applicable Documents

DesignGuide System (for PSB and MSB)	21-1S00-7D0001
Installation Instructions Self-regulating trace heating cables	01-5800-7D0003
Storage conditions	21-0000-7Q0001

corresponding manuals of the installed products or products to be use

Intended use

BARTEC Self-regulating trace heating cables types

- BARTEC PSB (07-5853-*)
- BARTEC MSB (07-5854-*)

can be used to create BARTEC Self-regulating trace heating systems types PSB or MSB in combination with BARTEC splice kits and junction boxes as follows:

- Installation Enclosures types PBS, PBM, ELL, PBTW, PBTC
- ESTM controller
- PLEXO TCS connectors

It is designed for industrial purposes in shown trace heating systems for freeze protection and temperature maintenance applications. It is

intended for use in hazardous (potentially explosive) gas or combustible dust atmospheres ("hazardous locations").

Operation is allowed with

- one kind of heating cable in each heating circuit only
- respect to the maximum heating circuit length
- installed earth fault equipment protection and overcurrent protection for each branch circuit

The approval and marking of the respective heating system, the technical data of the BARTEC Self-regulating trace heating cables and the applicable documents must be observed.

For use with electrical systems, the relevant installation and operating conditions (e.g. according to ATEX Directive 2014/34/EU, EN 60079-0, EN 60079-14, EN 60079-17, EN 60079-30-2 and any other relevant national standards) must be observed.

Specific Conditions of Use

For Specific Conditions of use see documents of components, the system is built with, as it is:

General (IECEx DEK 20.0055X); (DEKRA20ATEX0093 X)

All power and data line cable entries to the trace heater boxes shall be installed with Ex eb or Ex tb cable glands or blanking elements providing a minimum ingress protection of IP66.

Supply cables and power cable entry glands shall be selected per manufacturer's installation instructions for appropriate conductor size and temperature range (see chapter "Checklist customized entry port").

When used in TT and TN systems a residual current device according to IEC/IEEE 60079 30-1, clause 4.4 point c) 1) shall be installed.

When used in IT systems an insulation monitoring device according to IEC/IEEE 60079 30-1, clause 4.4 point c) 2) shall be used.

For the electrical data that are not marked, see Annex 1 to NL/DEK/ExTR20.0058/00.

Coated aluminium Power boxes, type 27-54P2-****/**** and Cable entries PS-120* type 27-59-G2-*

The enclosure must not be used in areas affected by charge-producing processes, mechanical friction and separation processes, electron emission (e.g. in the vicinity of electrostatic coating equipment), and pneumatically conveyed dust.

PBTW, Ex d Temperature Controller Type 27-54D*-****/****

The width of gap of the Ex d Temperature Switch is below the maximum values according to IEC 60079-1. Contact BARTEC for maintenance or repair of Ex d Temperature Switch.

The capillary of the PBTW and PT100 wiring shall be part of a fixed installation and shall be effectively clamped to prevent pulling or twisting.

PBTW, PBTC, Temperature Controller Type 27-54** -****/****

Shall be applied for maintaining temperature only.

The capillary of the PBTW and PT100 wiring shall be part of a fixed installation and shall be effectively clamped to prevent pulling or twisting.

Heating system PLEXO TCS type 27-59P*-****/****

The classification of the temperature class of the PLEXO TCS Heating System is done from the operator depending on the used heating cable. The ambient temperature range of PLEXO TCS Heating System depends also of the used heating cable. This information is recorded on the operator side in accordance with the specifications in the operating instructions / acceptance report. The documentation must be kept secure.

Temperature Controller, ESTM type, 17-88C1-*22H****

Cable glands shall be used that are certified for the applicable type of protection and with suitable ratings. For EPL Db only cable glands with integrated seal or gasket may be used.

In order to ensure safe operation of the Ex ib circuits, the ground or earth connections of all electrical circuits connected to the Temperature Controller shall be installed using potential equalization between the hazardous area and the non-hazardous area.

Shall be applied for maintenance temperature control only. The use of optional Limiter ESTM-L, 17-88C1-*22H**** is not in the scope.

Self-Regulating Heating Cable Series PSB, type 07-5853-**** and MSB, type 07-5854.****

Connections and terminations for installation with the Self-Regulating Heating Cable Series PSB and MSB shall be certified according to the requirements of the applicable standards for the types of protection for potentially flammable gas or combustible dust atmosphere, or as the requirements of IEC/IEEE 60079-30-1 as integral components. The connections and terminations shall be suitable for the application and correctly installed.

Foreseeable Misuse

The following activities are a misuse of the product and are not allowed:

- Use of the BARTEC Self-regulating trace heating cables for purposes other than those described in the intended use
- Installation, commissioning, operation, maintenance or disposal by unauthorised or unqualified personnel
- Work on live parts or circuits without switching off the BARTEC Self-regulating trace heating cables or the system
- Commissioning of damaged or faulty system components or incomplete installation.
- Recommissioning after dismantling the heating grommet without replacing the heating grommet.
- Unauthorized technical modification of the BARTEC Self-regulating trace heating cables

Personal Qualification

For system planning, installation, commissioning, operation and maintenance observe the requirements for personnel qualification according to DIN/EN 60079-14, note appendix A.

Applicability

This document covers the design of BARTEC PSB and MSB trace heating systems. It includes mainly engineering procedures for certified components as set out in section **System design**.

The manuals shipped together with the individual components will contain additional relevant content to this document.

Relevancy of individual sections of this document is highlighted at the beginning of each section.

The self-regulating trace heating system type 27-1S** is a trace heating system for fixed installation in hazardous areas with explosive gas, vapour or dust atmosphere. It is to be used for frost protection, to raise or maintain the temperature of a workpiece where it is externally applied.

⚠ CAUTION

The trace heating system is only applicable in case of workpiece temperature is higher than the layout ambient temperature.

⚠ WARNING

Risk of fire or electrical shock.

Risk of lost explosion protection.

The maximum Trace heater steady-state current is to be observed!

Protecting of all components of the Trace heater Installation Enclosure against over-heat is controlled by maximum Heating circuit length, depending on design parameters.

Observe the trace heater steady state current listed on table "Installation Enclosures for Trace Heating as Power Box kit"!

Technical data

Self-regulating trace heating system

Protection classification Ⓢ II 2G Ex db eb mb [ib] 60079-30-1 IIC T6...T3 Gb
 Ⓢ II 2D Ex tb [ib] 60079-30-1 IIIC T_L 80 °C... T_L 170 °C Db

Trace heater

	PSB	MSB
Max. continuous operating temperature, energized	65 °C	110 °C
Max. continuous exposure temperature, de-energized	85 °C	130 °C
Min. start-up temperature	-55 °C	-60 °C
Min. installation temperature	-55 °C	-60 °C
Power Output¹	10, 15, 25, 33 W/m	10, 15, 30, 45, 60 W/m
Nominal voltage	110 V to 120 Vac / 208 V to 277 Vac	110 V to 120 Vac / 208 V to 277 Vac
Max. braid resistance	< 18.2 Ω/km	< 18.2 Ω/km
Braid material	Tinned copper	Nickel-plated copper
Min. bending radius	25 mm (Do not bend on the narrow axis.)	25 mm (Do not bend on the narrow axis.)
Cable weight	13 kg/100 m	11.5 kg/100 m
Heater dimensions	<i>fluoropolymer outer jacket</i>	11.6 x 5.6 mm
	<i>polyolefin outer jacket</i>	11.8 x 5.8 mm
Temperature classes	T6: 3PSB2, 5PSB2 T5: 8PSB2, 10PSB2	T4: 3MSB2, 5MSB2 T3: 10MSB2, 15MSB2, 20MSB2
Protection classification	Ⓢ II 2G Ex 60079-30-1 IIC T5, T6 Gb Ⓢ II 2D Ex 60079-30-1 IIIC T95 °C, T80 °C Db	Ⓢ II 2G Ex 60079-30-1 IIC T3, T4, T5, T6 Gb Ⓢ II 2D Ex 60079-30-1 IIIC T170 °C, T130 °C, T95 °C, T80 °C Db

¹ nominal heat output at 10 °C

Trace heater Installation Enclosure as Power Box kit

Junction box with mounting stand								
	PBS-200-E /-E10 / -E16	PBS-300-E /-E10 / -E16	PBM-200-E /-E10 / -E16	PBM-300-E /-E10 / -E16	PBTW-200-E	PBTW-300-E	PBTC-200-E	PBTC-300-E
Max. workpiece temperature mounting stand ²	+240 °C	-	+240 °C	-	+240 °C	-	+240 °C	-
Max. trace heater entries	2	1	3	3	2	1 (3 ^s)	1	1
Terminals	Spring clamp Ex e; 2x3 lines, 1x3 PE		Spring clamp Ex e; 3x3 lines, 2x3 PE		Spring clamp Ex e; 4x3 lines, 2x3 PE		Spring clamp Ex e; 2 x lines, 2 x neutral, 2 x PE	
Maximum circuit breaker size ⁴	32 A				16 A		32 A	
Power supply	max. 277 Vac							
Ambient temperature range	-55 °C to +55 °C						-40 °C	
Min. installation temperature	-55 °C						-40 °C	
Power supply cable Service temperature at conductor ⁵	MSB: 70 °C @ Ta max 40 °C 80 °C @ Ta max 55 °C				PSB: 70 °C @ Ta max 40 °C 85 °C @ Ta max 55 °C 80 °C @ Ta max 55 °C (@ 24 A max.)			
Ingress Protection	IP 66						IP 64; IP 66 (EN 60529)	

Connection Technology (CAK)

Maximum withstand temperature / max. service temperature end seal	+200 °C
Min. installation temperature	-60 °C

Connected trace heater type	Trace heater rated power output [W/m]	T _{amb max} [°C]	Limitation of operating current (steady state) of trace heating circuit at T _{amb max} [A]				Max. surface temperature "T _L " [°C]		T-class
			PBS/PBM	ESTM	PBTC	PBTW **	Installation enclosure #	Trace heater ##	System ###
PSB	10, 15	+40	30	16	19	16	+110	+80	T4
			27	16	18	15	+95	+80	T5
			23	16	-	9	+80	+80	T6
		+55	26	16	12	16	+110	+80	T4
			24	16	12	15	+95	+80	T5
			18	16	-	9	+80	+80	T6
	25, 33	+40	30	16	19	16	+110	+95	T4
			27	16	18	15	+95	+95	T5
		+55	26	16	12	16	+110	+95	T4
			24	16	12	15	+95	+95	T5
MSB	10, 15	+40	20	16	19	16	+110	+130	T4
		+55	18	16	*12	16	+110	+130	T4
	30, 45, 60	+40	20	16	19	16	+110	+170	T3
			18	14	*12	16	+110	+170	T3

² Maximum workpiece temperature depending on the type of trace heater, used

³ On request

⁴ Protecting of all components of the branch circuit against over-current; choice depending on design parameters

⁵ For supply cable type selection, the permissible operating temperature at the conductor is to be observed with respect to the maximum ambient temperature of the power box.

Notes

* Limitations may apply to the trace heater circuit length, in order not to exceed the maximum allowed operating current (steady state). Consult the manufacturers trace heating system design documentation, containing the calculated operating current of the applicable trace heating circuit.

** PBTW is limited to use in trace heating circuits protected by a 16 A rated over current protection, see electrical data above.

Maximum surface temperature of installation enclosures:

- with trace heaters installed and operating (with steady state operating current);

- with the installation enclosures positioned in the worst case orientation with maximum amount of accumulated dust layer (limitations to the orientation of installation do not apply).

Maximum sheath temperature trace heater, installed on workpiece.

System comprising installation enclosure and trace heaters.

Trace heater Installation Enclosure as *End of Line Light* kit and *End of Line Seal* kit

Junction box with mounting stand			
	ELL-200-E	ELL-300-E	ELS-200-E
Max. workpiece temperature mounting stand ³	+240 °C	-	+240 °C
Terminals	Spring clamp Ex e: 1x3 PE ComEx Lamp module	Spring clamp Ex e: 1x3 PE ComEx Lamp module	-
Max. power conductor size	Trace heater bus wires only		
Maximum circuit breaker size: ⁶	32 A		
Power supply	max. 277 Vac		
Ambient temperature range	-55 °C to +40 °C		-55 °C to +55 °C
Min. installation temperature	-55 °C		
Ingress Protection	IP 64; IP 66 (EN 60529)		IP 66 (EN 60529)

Connection Technology (CAK)		
Maximum withstand temperature / max. service temperature end seal	-	+200 °C
Min. installation temperature	-60 °C	

System components			
	Plexo TCS Heating System		ESTM Temperature Controller
Workpiece temperature range ⁷	-60 °C to +160 °C		-
Terminals	Spring clamp 0,5 mm ² to 4 mm ²		Spring clamp Power cable 6 mm ² , Control cables 2.5 mm ²
Maximum circuit breaker size ⁸	32 A		32 A
Power supply	max. 254 Vac		230 V +10%-20%, 50 Hz
Ambient temperature range	-		-55 °C to +55 °C
Min. installation temperature	-55 °C		-55 °C
Minimum Temperature resistance of supply cable ⁹	PSB: +80 °C for system in T5 +75 °C for system in T6	MSB: +125 °C for system in T3 +95 °C for system in T4	-
Sealing area supply cables	9 mm to 16 mm (for types 27-59P1.../...)		12 mm to 17 mm power cable 5 mm to 8 mm control cable
Ingress protection	IP 65 IP 66, IP 68 (EN 60529)		IP 65

⁶ Protecting of all components of the branch circuit against over-current; choice depending on design parameters

⁷ Observe Technical Data of the Heating Cable

⁸ Protecting of all components of the branch circuit against over-current; choice depending on design parameters

⁹ For supply cable type selection, the permissible operating temperature at the conductor is to be observed with respect to the maximum ambient temperature of the product

System design

For the design of trace heating systems with BARTEC self-regulating trace heaters, the following steps are necessary:

- Trace heater selection
- Determination of the total required trace heater length
- Determination of the required number of trace heating circuits
- Selection of the required components and accessories for power connection, control and monitoring, end termination etc.

The following sections provide step-by-step instructions on how to proceed with each step.

Trace heater selection

Step 1: Familiarize yourself with the trace heater types and their properties

BARTEC self-regulating trace heaters are available in various types to suit different applications. Each trace heater is marked with a product code that contains relevant information as shown in the following example:

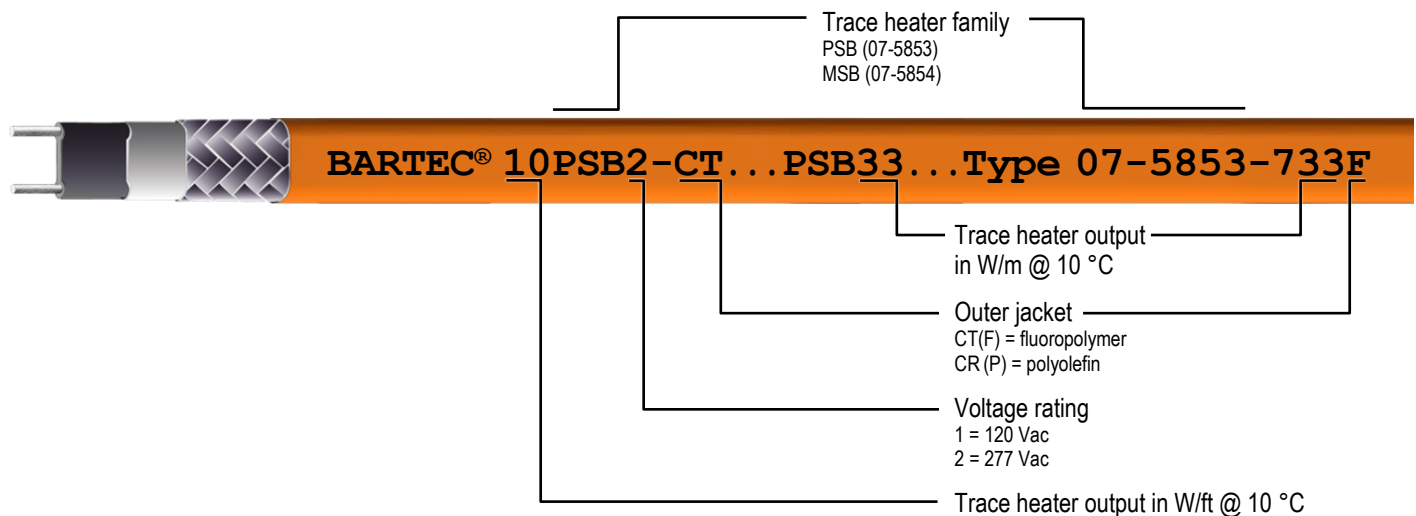

→ Example

A trace heater that bears the marking **10PSB2-CT...PSB33...Type 07-5853-733F** has the following specifications:

- Trace heater output @ 10 °C: **33 W/m (10 W/ft)**
- Trace heater family: **PSB**
- Voltage rating: **230 Vac**
- Outer jacket: **fluoropolymer**

Step 2: Determine the heat loss of your pipe setup

For proper system design it is essential to know the effective heat loss of your pipe setup. To determine it, the following data will be required:

- Pipe diameter
- Insulation thickness
- Insulation material
- Maintain temperature
- Minimum ambient temperature
- Temperature differential ΔT : $\Delta T = \text{maintain temperature} - \text{minimum ambient temperature}$

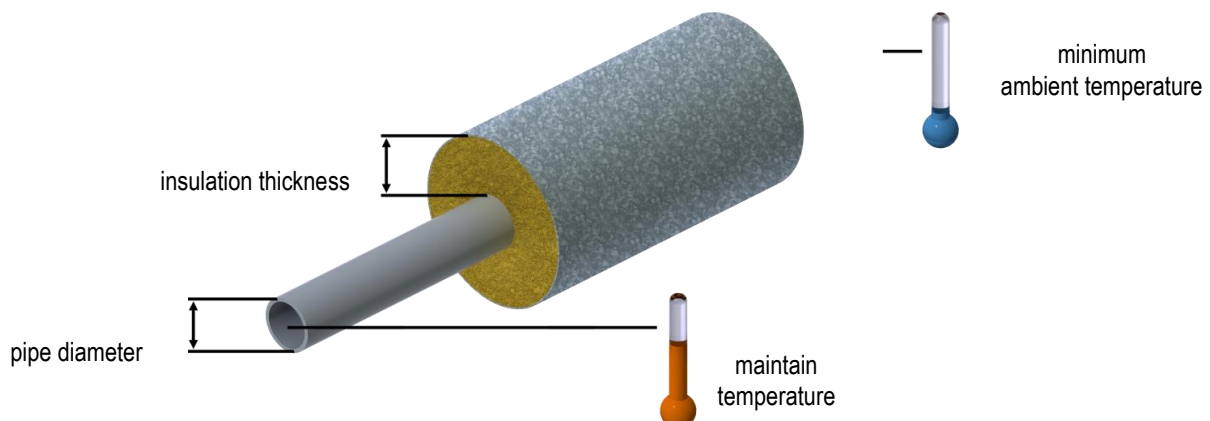

Next, obtain the basic heat loss in W/m using the following table¹⁰:

		Table A: Basic heat loss in W/m																		
		ΔT in °C	Pipe ϕ in DN (inch)	DN8 (1/4")	DN10 (3/8")	DN15 (1/2")	DN20 (3/4")	DN25 (1")	DN32 (1 1/4")	DN40 (1 1/2")	DN50 (2")	DN65 (2 1/2")	DN80 (3")	DN100 (4")	DN125 (5")	DN150 (6")	DN200 (8")	DN250 (10")	DN300 (12")	
Insulation thickness in mm	15	25	5.0	5.8	6.7	7.8	9.2	11.0	12.1	14.5	17.6	20.1	25.0	29.9	35.5	45.3	55.6	65.4		
		35	7.2	8.3	9.5	11.2	13.1	15.6	17.3	20.6	25.0	28.6	35.6	42.6	50.5	64.5				
		45	9.3	10.8	12.4	14.5	17.0	20.3	22.4	26.8	32.5	37.1	46.3	55.4	65.6					
		75	16.0	18.5	21.2	24.9	29.3	34.8	38.5	46.0	55.8									
		100	22.1	25.6	29.4	34.5	40.5	48.2	53.3											
		125	28.9	33.5	38.4	45.0	52.9													
	20	25	4.3	4.9	5.6	6.5	7.5	8.9	9.8	11.6	13.9	15.8	19.5	23.3	27.4	34.9	42.7	50.1		
		35	6.1	7.0	8.0	9.2	10.7	12.6	13.9	16.5	19.8	22.5	27.8	33.1	39.1	49.7	60.8			
		45	7.9	9.1	10.3	12.0	13.9	16.4	18.0	21.4	25.7	29.2	36.2	43.0	50.8	64.5				
		75	13.6	15.6	17.7	20.6	23.9	28.2	31.0	36.7	44.2	50.2	62.1							
		100	18.9	21.6	24.5	28.4	33.1	39.0	42.9	50.8	61.1									
		125	24.6	28.2	32.1	37.2	43.2	50.9	56.0											
	25	25	3.8	4.3	4.9	5.6	6.5	7.6	8.3	9.8	11.7	13.2	16.2	19.2	22.6	28.6	34.9	40.8		
		35	5.4	6.2	7.0	8.0	9.2	10.8	11.8	13.9	16.6	18.8	23.1	27.4	32.2	40.7	49.7	58.2		
		45	7.1	8.0	9.1	10.4	12.0	14.0	15.4	18.1	21.6	24.4	30.0	35.6	41.8	52.8	64.5			
		75	12.2	13.8	15.6	17.9	20.6	24.1	26.4	31.0	37.1	41.9	51.5	61.1						
		100	16.8	19.1	21.5	24.7	28.5	33.3	36.5	42.9	51.3	58.0								
		125	22.0	24.9	28.1	32.3	37.3	43.5	47.7	56.1										
	30	25	3.5	4.0	4.4	5.0	5.8	6.7	7.3	8.6	10.2	11.4	14.0	16.5	19.3	24.3	29.6	34.6		
		35	5.0	5.6	6.3	7.2	8.2	9.6	10.4	12.2	14.5	16.3	19.9	23.5	27.5	34.6	42.2	49.3		
		45	6.5	7.3	8.2	9.3	10.7	12.4	13.6	15.8	18.8	21.2	25.9	30.5	35.7	45.0	54.8	64.0		
		75	11.1	12.5	14.0	16.0	18.4	21.3	23.3	27.2	32.3	36.4	44.4	52.4	61.4					
		100	15.4	17.3	19.4	22.2	25.4	29.5	32.2	37.6	44.6	50.3	61.4							
		125	20.1	22.7	25.4	29.0	33.2	38.5	42.0	49.1	58.3									
40	25	3.1	3.4	3.8	4.3	4.9	5.6	6.1	7.0	8.2	9.2	11.2	13.0	15.2	19.0	23.0	26.7			
	35	4.4	4.9	5.4	6.1	7.0	8.0	8.6	10.0	11.7	13.1	15.9	18.6	21.6	27.0	32.7	38.1			
	45	5.7	6.3	7.0	8.0	9.0	10.3	11.2	13.0	15.2	17.1	20.6	24.2	28.1	35.1	42.5	49.4			
	75	9.8	10.9	12.1	13.7	15.5	17.8	19.3	22.3	26.2	29.3	35.4	41.5	48.3	60.3					
	100	13.5	15.1	16.7	18.9	21.4	24.6	26.6	30.8	36.2	40.5	49.0	57.4							
	125	17.6	19.7	21.8	24.7	28.0	32.1	34.8	40.3	47.3	52.9									
50	25	2.8	3.1	3.4	3.8	4.3	4.9	5.3	6.1	7.1	7.9	9.4	11.0	12.7	15.7	19.0	22.0			
	35	4.0	4.4	4.9	5.4	6.1	7.0	7.5	8.6	10.1	11.2	13.4	15.6	18.1	22.4	27.0	31.3			
	45	5.2	5.7	6.3	7.1	8.0	9.1	9.8	11.2	13.1	14.6	17.4	20.3	23.5	29.1	35.1	40.7			
	75	8.9	9.8	10.8	12.2	13.7	15.6	16.8	19.3	22.4	25.0	30.0	34.9	40.3	50.0	60.2				
	100	12.3	13.6	15.0	16.8	18.9	21.5	23.2	26.7	31.0	34.6	41.4	48.2	55.8						
	125	16.0	17.8	19.6	22.0	24.7	28.1	30.4	34.8	40.6	45.1	54.1								
100	25	2.2	2.4	2.5	2.8	3.1	3.4	3.6	4.1	4.6	5.0	5.9	6.7	7.6	9.2	10.8	12.3			
	35	3.1	3.3	3.6	4.0	4.4	4.9	5.2	5.8	6.6	7.2	8.4	9.5	10.8	13.0	15.4	17.6			
	45	4.0	4.3	4.7	5.2	5.7	6.3	6.7	7.5	8.5	9.3	10.9	12.4	14.0	17.0	20.0	22.8			
	75	6.8	7.5	8.1	8.9	9.8	10.8	11.5	12.9	14.7	16.0	18.7	21.2	24.1	29.1	34.3	39.2			
	100	9.5	10.3	11.2	12.3	13.5	15.0	16.0	17.9	20.3	22.2	25.8	29.4	33.3	40.2	47.5	54.2			
	125	12.4	13.5	14.6	16.0	17.6	19.6	20.8	23.3	26.5	29.0	33.7	38.4	43.6	52.6	62.0	70.9			

¹⁰ Heat loss calculations are based on IEC/IEEE 60079-30-1:2015 Annex C and IEC/IEEE 60079-30-2:2015 Annex E. The following assumptions have been made:

- Medium not in motion
- Single layer insulation
- No gap between pipe and insulation layer
- No gap between insulation layer and weather shielding
- Ambient temperature: -20 °C
- Outdoor installation, wind speed: 20 m/s
- Application of a safety factor of +10 %

For other values contact your local BARTEC distributor.

Finally, you must apply the following correction factors depending on your insulation material:

		Table B: Insulation Correction Factors	
		Correction Factor*	thermal conductivity at 20 °C in W/m·K
Insulation material	Rockwool / Mineral Fibre (ASTM C547-15 Type II)	1.00	0.0370
	Calcium Silicate (ASTM C533 Type I)	1.47	0.0567
	Cellular glass (ASTM C552-15 Type II)	1.46	0.0481
	Rigid cellular urethane (ASTM C591-13 Type I)	0.83	0.0275
	Foamed elastomer Grade 2 (ASTM C534-14)	1.29	0.0425
	Expanded perlite (ASTM C610-15)	2.06	0.0678
	Pyrogel XT (ASTM C1728-12)	0.56	0.0206

→ **Example**

- Pipe diameter: **DN25**
 - Insulation thickness: **20 mm**
 - Insulation material: **calcium silicate**
 - Minimum ambient temperature: **-20 °C**
 - Maintain temperature: **25 °C**
- } $\Delta T = 25\text{ °C} - (-20\text{ °C}) = 45\text{ °C}$

We obtain the basic heat loss in W/m from Table A on page 10:

		Pipe ϕ in DN (inch)						
		DN8 (1/4")	DN10 (3/8")	DN15 (1/2")	DN20 (3/4")	DN25 (1")	DN32 (1 1/4")	
Insulation thickness in mm	15	25	5.0	5.8	6.7	7.8	9.2	11.0
		35	7.2	8.3	9.5	11.2	13.1	15.6
		45	9.3	10.8	12.4	14.5	17.0	20.3
		75	16.0	18.5	21.2	24.9	29.3	34.8
		100	22.1	25.6	29.4	34.5	40.5	48.2
		125	28.9	33.5	38.4	45.0	52.9	
	20	25	4.3	4.9	5.6	6.5	7.5	8.9
		35	6.1	7.0	8.0	9.2	10.7	12.6
		45	7.0	8.1	9.3	10.7	12.4	14.4
		75	13.6	15.6	17.7	20.6	23.9	28.2
		100	18.9	21.6	24.5	28.4	33.1	39.0

basic heat loss: **13.9 W/m**

Now, the correction factors from Table B must be checked and, if necessary, applied:

		Correction Factor*
Insulation material	Rockwool / Mineral Fibre (ASTM C547-15 Type II)	1.00
	Calcium Silicate (ASTM C533 Type I)	1.47
	Cellular glass (ASTM C552-15 Type II)	1.46
	Rigid cellular urethane (ASTM C591-13 Type I)	0.83
	Foamed elastomer Grade 2 (ASTM C534-14)	1.29
	Expanded perlite (ASTM C610-15)	2.06
	Pyrogel XT (ASTM C1728-12)	0.56

correction factor insulation: **1.47**

The effective heat loss of the setup is determined as follows:

effective heat loss = basic heat loss × correction factor insulation
 = 13.9 W/m × 1.47
 = 20.4 W/m

Step 3: Choose a trace heater family

Determine the requirements for your trace heating application:

- Maximum exposure temperature (power on / power off)
- Minimum operation / installation temperature
- Required heat output to compensate for the effective heat loss as calculated in Step 2
- Required temperature class (“T-Rating”)

Select the trace heater family that meets your requirements using the following table:

<i>Table C: Trace heater family selection</i>			
	<i>PSB</i>	<i>MSB</i>	
Max. continuous operating temperature, energized	65 °C	110 °C	
Max. continuous exposure temperature, de-energized	85 °C	130 °C	
Min. start-up temperature	-55 °C	-60 °C	
Min. installation temperature	-55 °C	-60 °C	
Power output¹¹	10, 15, 25, 33 W/m	10, 15, 30, 45, 60 W/m	
Nominal voltage	110 to 120 Vac 208 to 277 Vac	110 to 120 Vac 208 to 277 Vac	
Braid resistance	< 18.2 Ω/km	< 18.2 Ω/km	
Minimum bending radius	25 mm Do not bend on the narrow axis.	10 mm Do not bend on the narrow axis.	
Heater dimensions	11.6 x 5.6 mm (<i>fluoropolymer outer jacket</i>)	10.2 x 4.8 mm	
	11.8 x 5.8 mm (<i>polyolefin outer jacket</i>)		
Temperature classes¹²	<i>Product approach:</i> 10 W/m → T6 15 W/m → T6 25 W/m → T5 33 W/m → T5	<i>Product approach:</i> 10 W/m → T4 15 W/m → T4 30 W/m → T3 45 W/m → T3 60 W/m → T3 <i>Systems approach:</i> Operating temperature / T-Class is obtained by Heloc Pro calculation tool with respect to maximum Heating circuit length.	

NOTICE

If you want to use plastic piping within your installation, contact your local BARTEC distributor for verification that the design does not exceed the maximum withstand temperature of the pipe material. Also, adjustments in heat loss calculations may be required.

→ **Example**

- Maximum exposure temperature: **50 °C** (“power on”), **70 °C** (“power off”)
- Minimum operation temperature: **-20 °C**
- Required heat output: **20.4 W/m**
- Required temperature class: **T5**

Trace heater family that meets the requirements: **PSB**

¹¹ nominal heat output at 10 °C

¹² applies for the trace heater models with 208 to 277 Vac rated voltage; temperature classes according to IEC/IEEE 60079-30-1:2015 (max. surface temperature)

Step 4: Determine the required power rating

Since the power output of self-regulating trace heaters depends on the pipe temperature, the conditions within your application must be considered when choosing the trace heater:

- Determine the maintain temperature (= pipe temperature) of your application and the effective heat loss as calculated in Step 2.
- Find the required power output in the graph that contains the trace heater type and voltage you use (see tables on pages 14 to 14).
- If the required power output is between 2 trace heater types, choose the one with the higher rating.
- If the required power output exceeds the output of the trace heater with the highest rating, you may:
 - Use 2 or more trace heaters on the same pipe.
 - Use a thicker insulation or insulation material with a lower thermal conductivity.
 - Contact your local BARTEC distributor for further assistance.

→ Example

- Trace heater family as determined in Step 3: **PSB**
- Power supply voltage: **230 V**
- Maintain temperature: **25 °C**
- Effective heat loss: **20.4 W/m**

Trace heater that meets the required power output: **10PSB2**

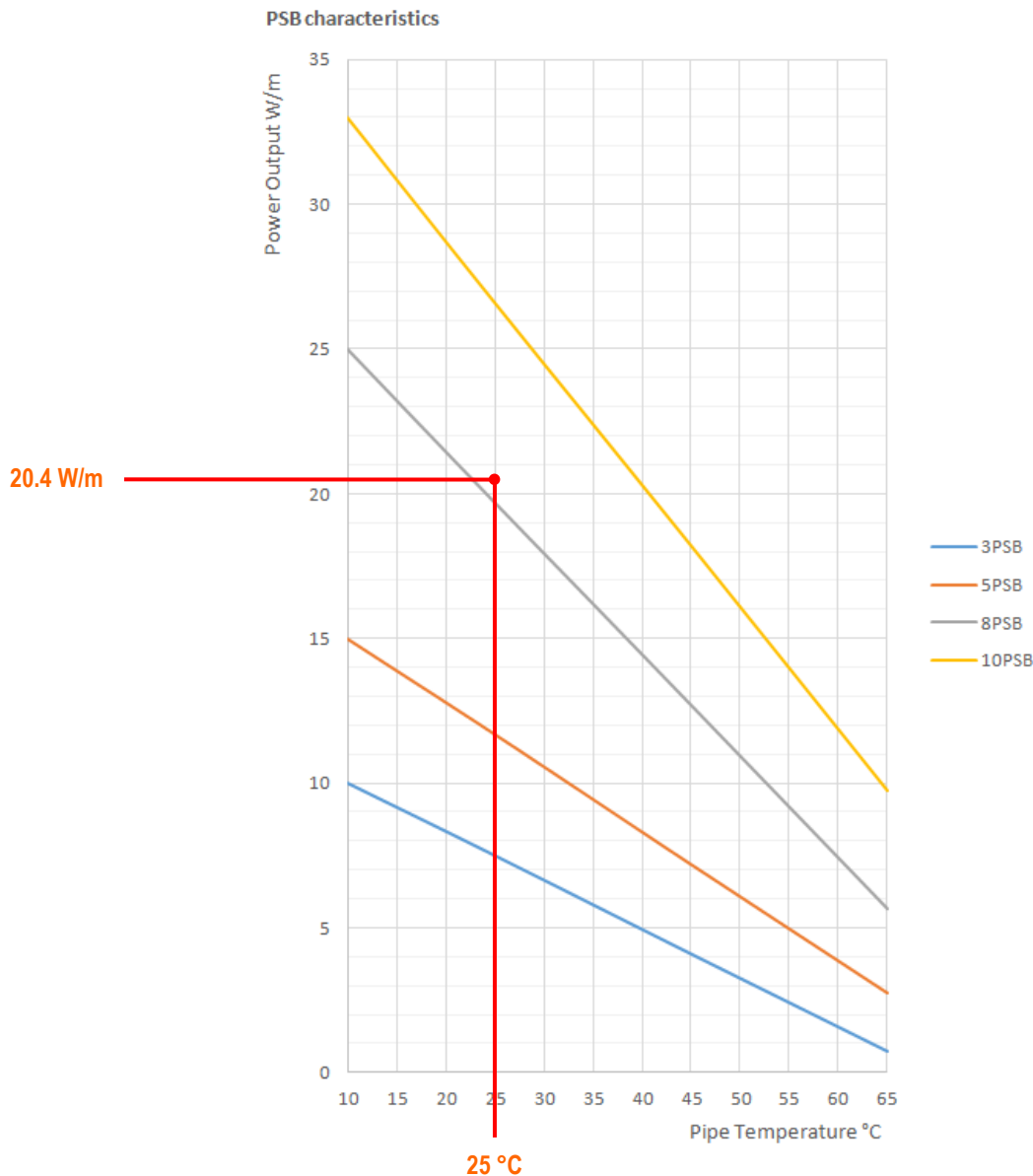
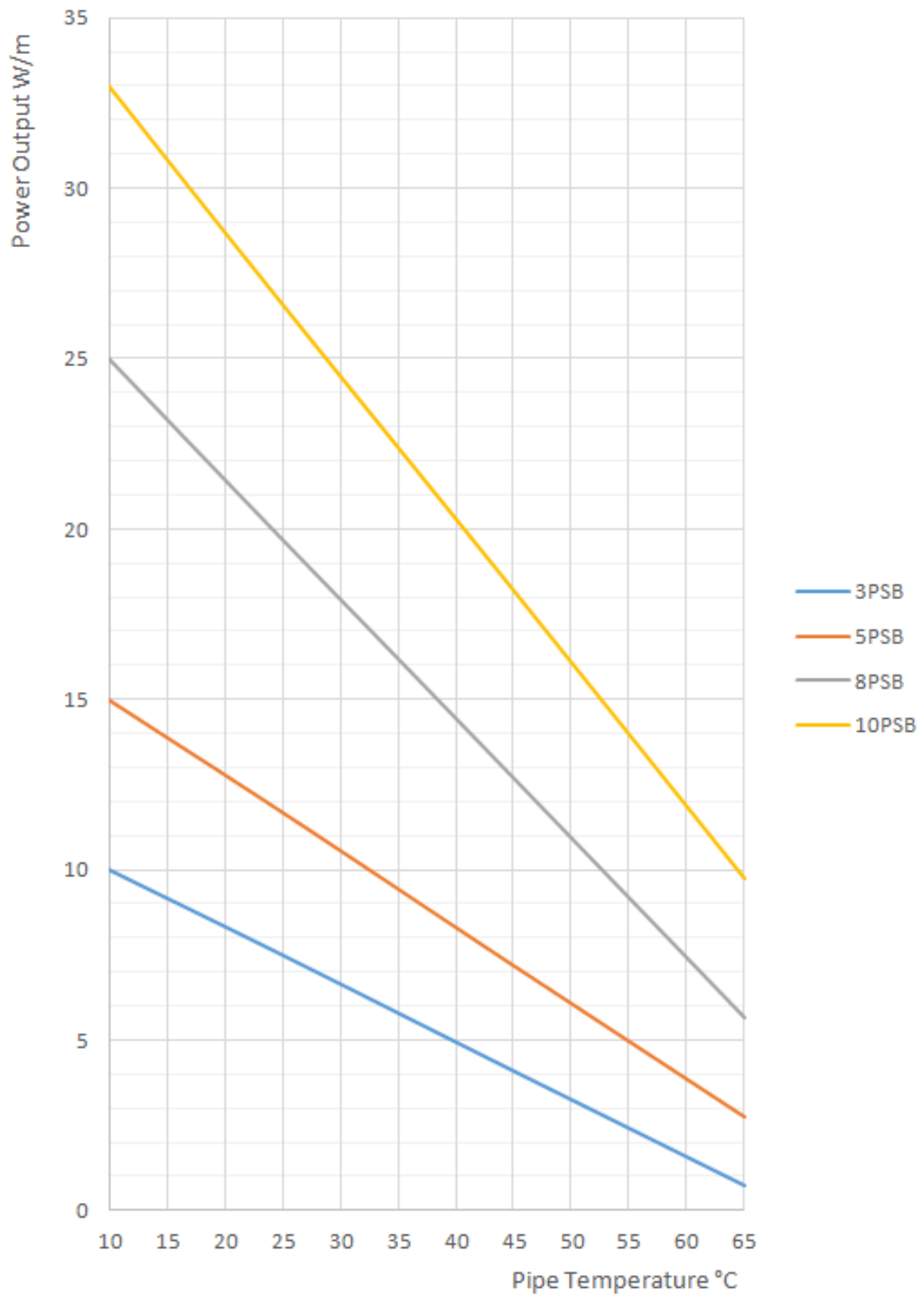

Table D: PSB 230V

PSB characteristics



For MSB trace heaters see next page.

Table E: MSB 230V

MSB characteristics

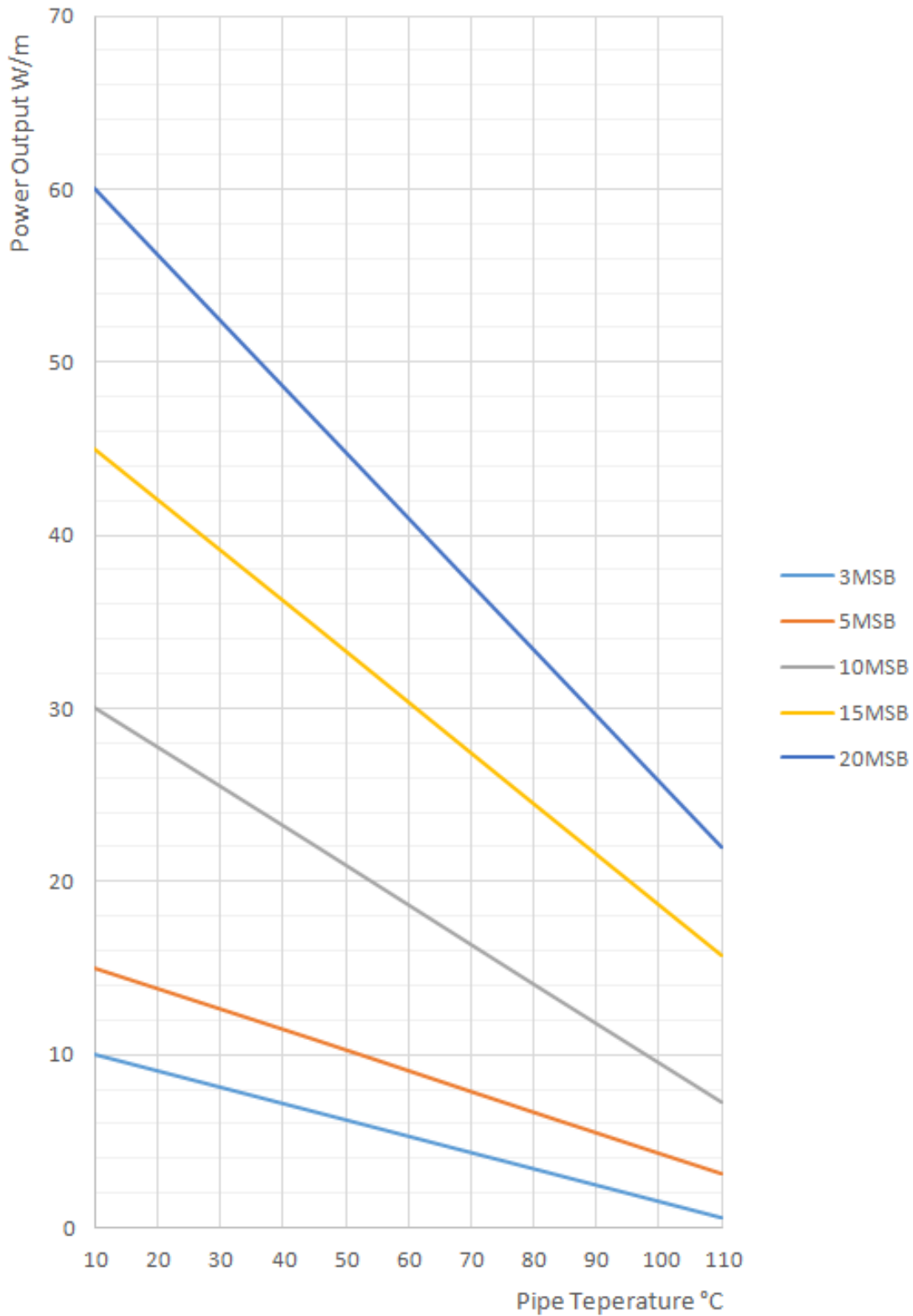

For PSB trace heaters see previous page.

Step 5: Select the appropriate outer jacket material

BARTEC self-regulating trace heaters are available with 2 different types of outer jackets. Choose the outer jacket that suits the chemical environment it will be exposed to. For questions regarding the chemical resistance please contact your local BARTEC distributor.

Table E: Chemical resistance of outer jackets			
	Application	Catalog No.	Type key (example)
Polyolefin outer jacket	exposure to aqueous, inorganic chemicals	...-CR	07-5853-733P (PSB only)
Fluoropolymer outer jacket	exposure to organic chemicals	...-CT	07-5853-733F (PSB) 07-5854-730F (MSB)

→ **Example**

- Trace heating systems for process applications in the oil industry: **fluoropolymer outer jacket**
- Trace heater catalog no. that meets the required power output and environmental conditions: **10PSB2-CT, Type 07-5853-733F**

Determination of the required trace heater length

The total required trace heater length is determined by taking into account the trace heater length for piping as well as allowances for valves, pumps, flanges, pipe supports and connection kits.

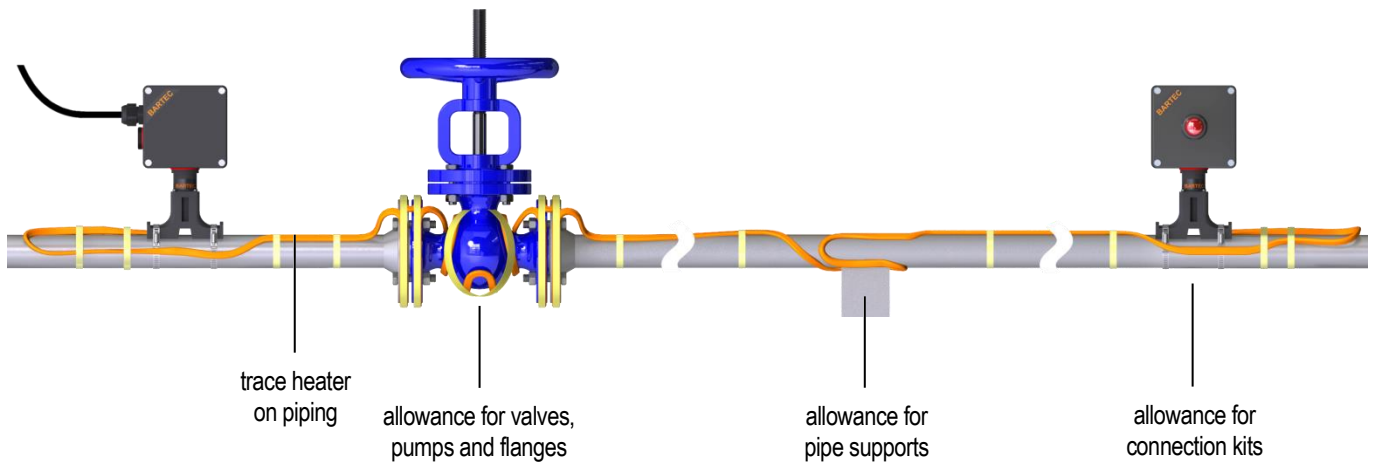

Step 6: Determine the required trace heater length for the piping:

The required trace heater length for piping corresponds to the pipe length.

→ **Example**

50 m of piping = **50 m of trace heater**

Step 7: Determine the required allowance for connection kits:

The required trace allowance for connection kits is 0.5 m for each kit.

→ **Example**

- Heating circuit with 1 power connection kit and 1 end of line lamp

The total required allowance is calculated as follows:

$$\begin{aligned}
 \text{total required allowance} &= \text{no. of connection kits} \times 0.5 \text{ m} \\
 &= 2 \times 0.5 \text{ m} \\
 &= \underline{1.0 \text{ m}}
 \end{aligned}$$

Step 8: Determine the required allowance for pumps, valves, flanges and pipe supports:

Determine the required allowances for pumps, valves, flanges and pipe supports using the following table:

Table F: Allowance values and pipe support intervals														
Pipe diameter in DN / inch	DN8 1/4"	DN15 1/2"	DN20 3/4"	DN25 1"	DN32 1 1/4"	DN40 1 1/2"	DN50 2"	DN65 2 1/2"	DN80 3"	DN100 4"	DN150 6"	DN200 8"	DN250 10"	DN300 12"
Allowance for pumps in m	1.5	2	2	2.1	2.3	2.3	2.4	2.4	2.4	2.6	3	3.5	4	4
Allowance for valves in m	0.5	0.5	0.5	0.6	0.6	0.7	0.7	1	1	1.3	1.5	1.6	1.8	2
Allowance for flanges in m	0.2	0.2	0.3	0.3	0.3	0.3	0.4	0.4	0.5	0.7	0.9	1	1.2	1.2
Allowance for pipe supports in m	0.2	0.2	0.3	0.3	0.3	0.3	0.4	0.4	0.5	0.7	0.9	1	1.2	1.2
Typical pipe support interval in m	1	1.5	1.5	2	2	2.5	3.1	4	4	5	6	7	8	8

→ **Example**

- Pipe diameter: DN25
- 1 pump
- 2 valves
- 6 flanges
- 24 pipe supports

The total required allowance is calculated as follows:

$$\begin{aligned}
 \text{total required allowance} &= \text{no. of pumps} \times \text{pump allowance value} + \\
 &\quad \text{no. of valves} \times \text{valve allowance value} + \\
 &\quad \text{no. of flanges} \times \text{flange allowance value} + \\
 &\quad \text{no. of pipe supports} \times \text{pipe support allowance value} \\
 &= 1 \times 2.1 \text{ m} + 2 \times 0.6 \text{ m} + 6 \times 0.3 \text{ m} + 24 \times 0.3 \text{ m} \\
 &= \underline{12.3 \text{ m}}
 \end{aligned}$$

Step 9: Add all lengths / allowances together:

Add the lengths for piping (as determined in step 6) and allowances (as determined in step 7 and step 8) together to obtain total required trace heater length.

→ **Example**

- required trace heater length for piping (step 6): **50 m**
- required allowances for connection kits (step 7): **1.0 m**
- required allowances for pumps, valves, flanges and pipe supports (step 8): **12.3 m**

$$\begin{aligned}
 \text{total required trace heater length} &= \text{required trace heater length for piping} + \text{required allowances} \\
 &= 50 \text{ m} + 1.0 \text{ m} + 12.3 \text{ m} \\
 &= \underline{63.3 \text{ m}}
 \end{aligned}$$

Determination of the required number of heating circuits

Step 10: Confirm the number of electrical circuits required for the application:

Using Table G on page 18, compare the required heater length and start up temperature to the available circuit breaker allowances to determine the number of electrical circuits that will be required.

→ **Example**

- total required trace heater length: **63.3 m**
- circuit breaker voltage: **230 Vac**
- selected trace heater: **10 PSB**
- circuit breaker amperage: **25 A**
- required start-up temperature: **-20 °C**

Circuit breaker size	Start-up temperature	PSB trace heaters			
		Operating voltage: 230 Vac			
		3PSB2	5PSB2	8PSB2	10PSB2
16 A	+10 °C	202 m	153 m	91 m	57 m
	0 °C	202 m	144 m	86 m	55 m
	-20 °C	163 m	115 m	70 m	44 m
20 A	+10 °C	202 m	165 m	120 m	76 m
	0 °C	202 m	165 m	107 m	67 m
	-20 °C	202 m	144 m	87 m	55 m
25 A	+10 °C	202 m	165 m	128 m	90 m
	0 °C	202 m	165 m	128 m	88 m
	-20 °C	202 m	165 m	109 m	69 m
32 A	+10 °C	202 m	165 m	128 m	97 m
	0 °C	202 m	165 m	128 m	97 m
	-20 °C	202 m	165 m	128 m	97 m

$$\begin{aligned}
 \text{allowable trace heater length from table below} &= \text{maximum of } 69 \text{ m at } -20 \text{ °C on } 25 \text{ A circuit breaker at } 230 \text{ Vac} \\
 &= 63.3 \text{ m calculated} < 69 \text{ m maximum allowable for } 25 \text{ A} = \underline{1 \text{ circuit}}
 \end{aligned}$$

The following table shows the maximum sum of trace heater lengths per branch circuit when connected to power through one or more system junction boxes.

If feeding multiple trace heating system circuits from the single circuit breaker, the maximum sum of trace heater lengths can then be extended. Please refer to BARTEC Heloc Pro design software or contact BARTEC technical support.

Breaker sizing should be based on international electric codes or any other local or applicable code. Use only circuit breakers with type C tripping characteristics.

WARNING

Risk of fire, electrical shock or dysfunction. Observe the maximum amperage of all components of the trace heating circuit. If the required trace heater length exceeds the maximum heating circuit length you must install multiple heating circuits.

The following tables G1 and G2 must be observed when selecting the max. heating circuit length.

Table G1 considers the fuse protection in relation to the min. switch-on temperature.

Table G2 considers the fuse protection in relation to the max. ambient temperature of the enclosure in which the heating cable is connected. The table refers to the Limitation of Operating Current (steady state) of the trace heating circuit at Tamb max [A].

Finally, the determined shorter length from both tables is to be applied.

Table G1: Maximum heating circuit length for circuit breakers with Type C tripping characteristics

Circuit breaker size	Start-up temperature	PSB trace heaters			
		Operating voltage: 230 Vac			
		3PSB2	5PSB2	8PSB2	10PSB2
16 A	+10 °C	202 m	153 m	91 m	57 m
	0 °C	202 m	144 m	86 m	54 m
	-20 °C	163 m	115 m	70 m	44 m
20 A	+10 °C	202 m	165 m	120 m	76 m
	0 °C	202 m	165 m	107 m	67 m
	-20 °C	202 m	144 m	87 m	55 m
25 A	+10 °C	202 m	165 m	128 m	95 m
	0 °C	202 m	165 m	128 m	84 m
	-20 °C	202 m	165 m	109 m	69 m
32 A	+10 °C	202 m	165 m	128 m	97 m
	0 °C	202 m	165 m	128 m	97 m
	-20 °C	202 m	165 m	128 m	88 m

Circuit breaker size	Start-up temperature	MSB trace heaters				
		Operating voltage: 230 Vac				
		3MSB2	5MSB2	10MSB2	15MSB2	20MSB2
16 A	+10 °C	230 m	164 m	92 m	67 m	52 m
	0 °C	217 m	155 m	87 m	64 m	49 m
	-20 °C	195 m	141 m	79 m	58 m	45 m
20 A	+10 °C	231 m	188 m	115 m	82 m	65 m
	0 °C	231 m	188 m	109 m	79 m	61 m
	-20 °C	231 m	177 m	98 m	72 m	56 m
25 A	+10 °C	231 m	188 m	133 m	82 m	75 m
	0 °C	231 m	188 m	133 m	82 m	75 m
	-20 °C	231 m	188 m	123 m	82 m	70 m
32 A	+10 °C	231 m	188 m	133 m	82 m	75 m
	0 °C	231 m	188 m	133 m	82 m	75 m
	-20 °C	231 m	188 m	133 m	82 m	75 m

Table G2: Maximum heating circuit length at maximum ambient temperature of the enclosure

Enclosure / trace heater	PSB trace heaters, Operating voltage: 230 Vac							
	+40°C				+55°C			
	3PSB	5PSB	8PSB	10PSB	3PSB	5PSB	8PSB	10PSB
PBS/PBM	202	165	128	97	202	165	128	97
ESTM	202	165	128	97	202	165	128	97
PBTC	202	165	128	97	202	165	128	97
PBTW	202	165	128	97	202	165	128	97

Enclosure / trace heater	MSB trace heaters, Operating voltage: 230 Vac									
	+40°C					+55°C				
	3MSB	5MSB	10MSB	15MSB	20MSB	3MSB	5MSB	10MSB	15MSB	20MSB
PBS/PBM	231	188	133	82	75	231	188	133	82	75
ESTM	231	188	111	80	63	231	188	108	77	61
PBTC	231	188	132	82	74	231	188	92	66	52
PBTW	231	188	111	80	63	231	188	123	82	70

For the ESTM temperature controller, the *Maximum heating circuit length* table please refer to the instructions manual of the ESTM.

Selection of the required components for power connection, control and monitoring, end termination etc.

A typical heating circuit with self-regulating trace heaters consists of:

- Power supply / cold lead cable connection
- Trace heater splices / junctions (optional)
- Control and monitoring units (optional)
- End termination

Step 11: Determine the required trace heater power connection kit:

→ **Example**

- From Step 10: 1 Heating circuit with 1 power connection kit = **PBS-200-E**

Step 12: Determine if control equipment is required:

BARTEC provides a variety of control products, from simple mechanical thermostats to sophisticated digital controllers and control and monitoring systems designed specifically for use with our trace heating products. This section will help you select and specify the right control products for your application.

General design considerations for temperature control:

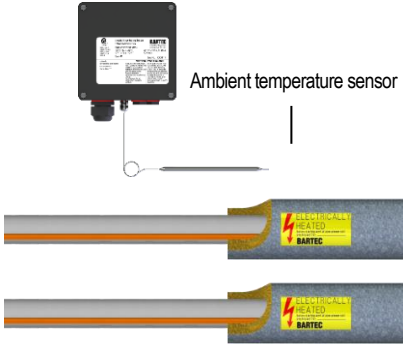
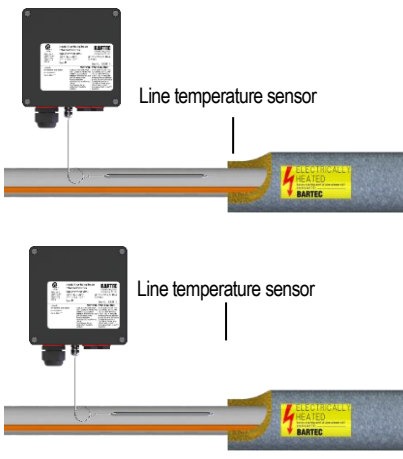

When designing your trace heating system, you should consider the following factors.

- Adding control elements increases the installation and maintenance costs of the heating system, but allows tighter temperature control, energy savings and more efficient use of plant maintenance personnel's time.
- The thermal environment of a trace heating system varies greatly, especially at valves, pipe supports, and other heat sinks. It is therefore seldom possible to achieve very tight temperature control.
- The temperature of a heat tracing system is based on ambient temperature and can vary by as much as 20 °C when the system is uncontrolled. You can choose between 2 approaches for temperature control:

<p>Ambient sensing control</p>	 <p>Ambient temperature sensor</p>	<p>Ambient sensing control:</p> <ul style="list-style-type: none"> ▪ uses an on-off thermostat that senses ambient temperature ▪ is more energy efficient than self-regulating control because the heating circuit is energized only when the temperature drops below the set-point ▪ is most suitable for freeze-protection applications where multiple circuits can be controlled by a single sensing point ▪ flow path considerations (flowing or non-flowing) are not required with ambient control.
<p>Line sensing control</p>	 <p>Line temperature sensor</p> <p>Line temperature sensor</p>	<p>Line sensing control:</p> <ul style="list-style-type: none"> ▪ regulates the desired maintain temperature by turning the heating circuit on if the pipe temperature falls below the set-point and turning it off if it exceeds the set-point ▪ the most energy-efficient method for controlling heat tracing is a line-sensing thermostat, because a flowing pipe will typically not need any additional heat to keep it at the proper temperature ▪ needs a separate circuit controlled by a line-sensing thermostat for each flow path ▪ where a piping system has tees and therefore multiple flow paths, more than one thermostat may be required.

NOTICE
 Line sensing provides tighter temperature control than ambient sensing but flow paths may require additional controllers.

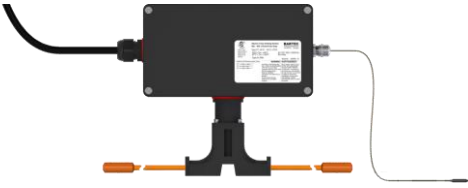
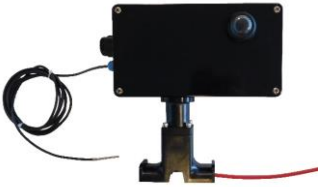
Overview of control equipment:

Mechanical thermostats		PBTW-200-E <ul style="list-style-type: none"> ▪ Adjustable set point mechanical thermostat with -20 °C to 50 °C or 0 °C to 190 °C range ▪ IP 66 rating in a GRP enclosure suitable for mounting on pipe ▪ SPDT switch
Electronic controllers		PBTC-200-E <ul style="list-style-type: none"> ▪ Adjustable set point electronic thermostat with a 0 °C to 500 °C range ▪ IP 66 rating in a GRP enclosure suitable for mounting on pipe ▪ RS485 communications interface, Modbus RTU ▪ SPDT switch
		ESTM-30 <ul style="list-style-type: none"> ▪ Continuous monitoring technology for heat-tracing faults ▪ Internal diagnostics and monitoring of the heat tracing current ▪ Integral ground fault monitoring, Bluetooth communication ▪ DPDT switch rated 30 A ▪ RS485 communications interface, Modbus RTU

Recommendations for selecting the appropriate control equipment:

Base your selection on the number and type of trace heating circuits to be installed, the type of control you need, and the area classification.

TABLE K: Control Equipment Selection Recommendations				
Heating circuit type	Application	Control options	Suitable BARTEC control product	Quantity required
Self-regulating heating circuits on pipes	Freeze protection	Ambient-sensing	PBTW-300-E (on panel)	1 per control panel
Self-regulating heating circuits on pipes	Temperature maintenance or tight temperature control	Line-sensing	PBTW-200-E (on pipe, local only)	1 per circuit
Multiple self-regulating heating circuit(s) for frost protection on tanks	Freeze protection or wide band temperature control	Line-sensing on a reference pipe	PBTC-200-E (on pipe, local only)	1 per control panel
Single self-regulating heating circuit(s) on temperature sensitive tanks	Temperature maintenance or tight temperature control	Point-sensing	PBTW (on panel or off tank, local only) PBTC-200-E (on pipe, local only) ESTM-30-E (local and remote indication)	1 per circuit

→ Example

- The application is temperature maintain for the pipe in a hazardous area. The ambient temperature is below the maintain temperature for only a few months every year and the customer wants to conserve energy. No remote indication or communication is required.

appropriate control equipment = PBTW-200-E

Note: Since the PBTW-200-E includes the power connection enclosure the PBS-200-E kit (from Step 11) is not required.

Step 13: Determine if monitoring equipment is required:

Monitoring increases system reliability by detecting faults before they become a major problem. Consider the following points when planning heating circuit monitoring:

- While you may select only one method of control for each trace heating circuit, you can make use of various monitoring options. The use of monitoring increases overall system reliability because failures in the heating and power distribution systems get reported to operations personnel.
- BARTEC recommends to always use, at a minimum, ground-fault monitoring. For the small additional cost, you get a monitoring system that reliably reports physical damage to the trace heating system, which is a common failure mode.
- For sensitive applications, add end of line monitoring with either a high profile end seal or an end of line light. The end of line light gives the most direct visual feedback on system performance.

Conventional system layout with monitoring panel and ground fault equipment protection device

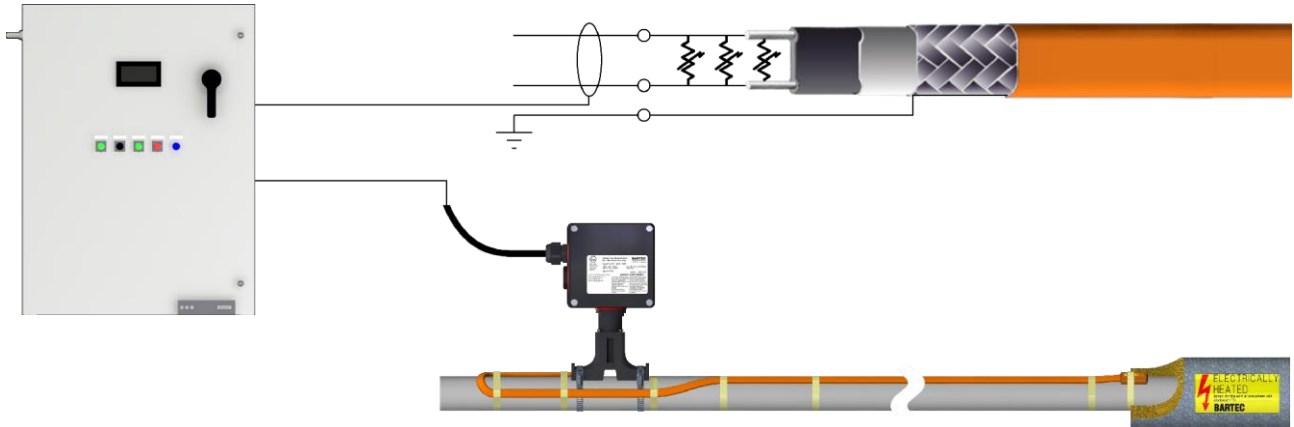

Maintenance access through a high profile end seal

The high profile end seal is used to quickly locate the end of the heating circuit for troubleshooting in the field. It provides a convenient way to locate the end of the circuit and for testing of voltage presence at the end of the circuit.

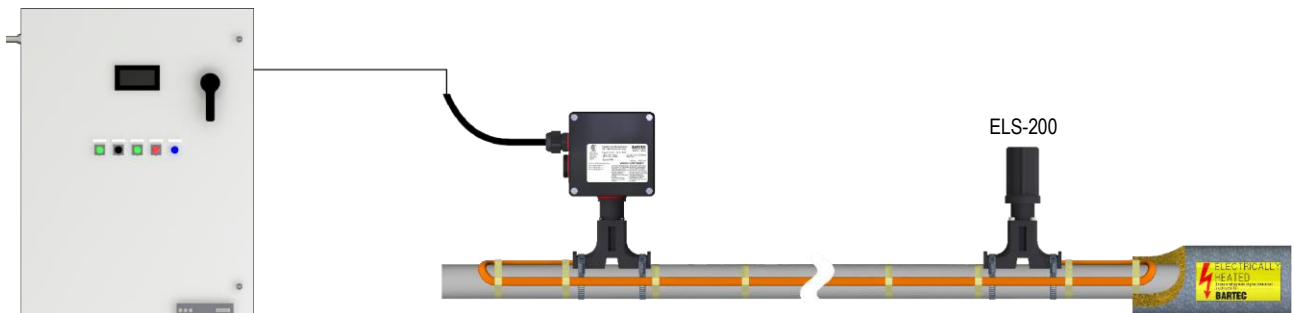

Continuity monitoring using an end of line light

Continuity monitoring is used to verify that the trace heater circuit has voltage present at the termination end. This is often assured by an end of line light installed as part of the end seal. In addition to the visual feedback at the end of the trace heater circuit it provides easy maintenance accessibility.

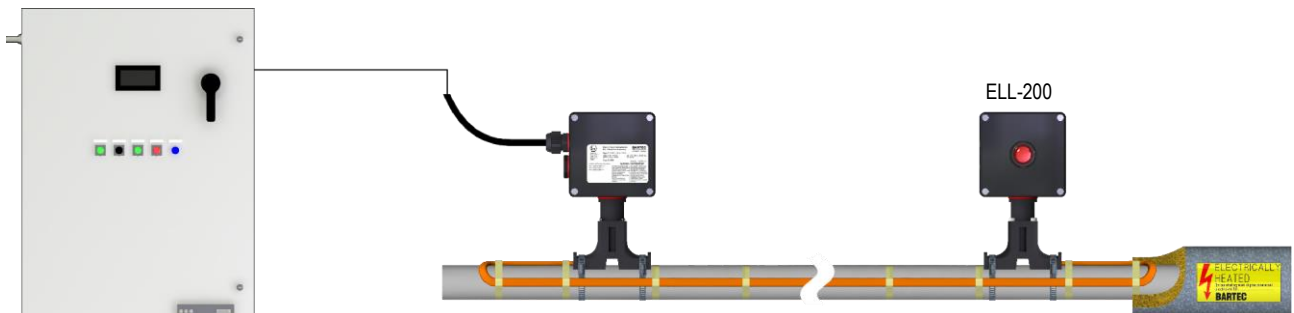

Table L: Selecting the appropriate monitoring equipment:

Base your selection on the number and type of trace heating circuits to be installed, the type of continuity monitoring you need, and the area classification:

TABLE L: Monitoring Equipment Selection Recommendations				
Heating circuit type	Application	Monitoring options	Suitable BARTEC monitoring product	Quantity required
Self-regulating heating circuits on pipes	Freeze protection	High profile end seal or signal light for indication	ELS-200 ELL-200	1 per circuit
Self-regulating heating circuits on pipes	Temperature maintenance or tight temperature control	High profile end seal	ELS-200	1 per circuit

→ **Example**

- The application is temperature maintenance (25 °C) of a pipe in a hazardous area.
- The maintenance team wants to be able to quickly locate the end seal.

appropriate monitoring equipment = ELS-200

Step 13: Finalize the required Materials List (BOM):

Accessories including the glass tape for attachment and pipe straps for the components and electrical traced warning labels

→ **Example**

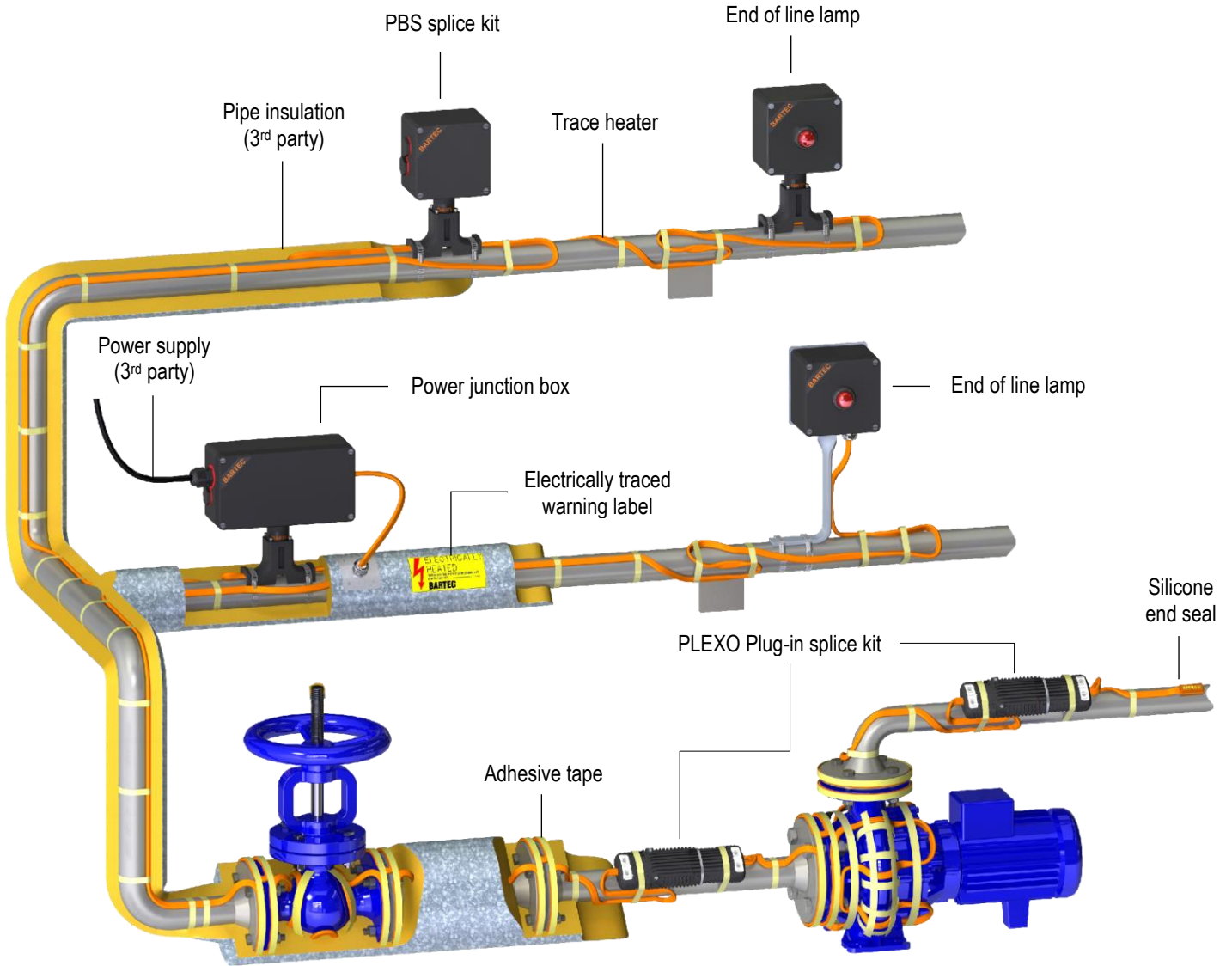

- | | | |
|--|-------------------|----------------|
| ▪ Heating cable catalog no. (see <i>Step 1-5</i> beginning on page 6) and required length (see <i>Step 9</i> on page 16) = | 10PSB2-CT | 64 m |
| ▪ Temperature control device including power connection enclosure (see <i>Step 12</i> on page 18) | PBTW-200-E | 1 pc. |
| ▪ High profile end seal for ease of maintenance (see <i>Step 12</i> on page 18) = | ELS-200 | 1 pc. |
| ▪ Accessories (see section <i>Accessories</i> on page 27-30): | | |
| Glass cloth tape (see selection table in section <i>Accessories</i>) | GT-164 | 1 rolls |
| Pipe straps (see selection table in section <i>Accessories</i>) | PC-1 | 4 pcs. |
| Electrically traced warning labels | HTWL-EN | 16 pcs. |

The following figure shows a sample heating circuit including typical components:





The following pages list compatible components for BARTEC Self-regulating trace heating systems in hazardous / industrial locations. The respective installation instructions are included in the scope of delivery.

Trace heaters

	<p>PSB trace heater with polyolefin outer jacket</p> <p>Self-regulating trace heater for installation on pipes, tanks etc.</p> <p><i>Polyolefin outer jacket: suitable for exposure to aqueous chemicals</i></p> <p><i>Approved for Zone 1/21 and Zone 2/22 areas.</i></p> <p><i>See data sheet for full details.</i></p>	<p>120 Vac</p> <p>10 W/m</p> <p>15 W/m</p> <p>25 W/m</p> <p>33 W/m</p>	<p><i>Catalog No.:</i></p> <p>3PSB1-CR</p> <p>5PSB1-CR</p> <p>8PSB1-CR</p> <p>10PSB1-CR</p>	<p><i>Order No.:</i></p> <p>439493</p> <p>439494</p> <p>439495</p> <p>439496</p>	<p><i>Part No.:</i></p> <p>07-5853-110P</p> <p>07-5853-115P</p> <p>07-5853-125P</p> <p>07-5853-133P</p>		
		<p>230 Vac</p> <p>10 W/m</p> <p>15 W/m</p> <p>25 W/m</p> <p>33 W/m</p>	<p><i>Catalog No.:</i></p> <p>3PSB2-CR</p> <p>5PSB2-CR</p> <p>8PSB2-CR</p> <p>10PSB2-CR</p>	<p><i>Order No.:</i></p> <p>439497</p> <p>439498</p> <p>439499</p> <p>439500</p>	<p><i>Part No.:</i></p> <p>07-5853-710P</p> <p>07-5853-715P</p> <p>07-5853-725P</p> <p>07-5853-733P</p>		
		<p>PSB trace heater with fluoropolymer outer jacket</p> <p>Self-regulating trace heater for installation on pipes, tanks etc.</p> <p><i>Fluoropolymer outer jacket: suitable for exposure to organic chemicals</i></p> <p><i>Approved for Zone 1/21 and Zone 2/22 areas.</i></p> <p><i>See data sheet for full details.</i></p>	<p>120 Vac</p> <p>10 W/m</p> <p>15 W/m</p> <p>25 W/m</p> <p>33 W/m</p>	<p><i>Catalog No.:</i></p> <p>3PSB1-CT</p> <p>5PSB1-CT</p> <p>8PSB1-CT</p> <p>10PSB1-CT</p>	<p><i>Order No.:</i></p> <p>439501</p> <p>439502</p> <p>439503</p> <p>439504</p>	<p><i>Part No.:</i></p> <p>07-5853-110F</p> <p>07-5853-115F</p> <p>07-5853-125F</p> <p>07-5853-133F</p>	
			<p>230 Vac</p> <p>10 W/m</p> <p>15 W/m</p> <p>25 W/m</p> <p>33 W/m</p>	<p><i>Catalog No.:</i></p> <p>3PSB2-CT</p> <p>5PSB2-CT</p> <p>8PSB2-CT</p> <p>10PSB2-CT</p>	<p><i>Order No.:</i></p> <p>439505</p> <p>439506</p> <p>439507</p> <p>439508</p>	<p><i>Part No.:</i></p> <p>07-5853-710F</p> <p>07-5853-715F</p> <p>07-5853-725F</p> <p>07-5853-733F</p>	
			<p>MSB trace heater</p> <p>Self-regulating trace heater for installation on pipes, tanks etc.</p> <p><i>Fluoropolymer outer jacket: suitable for exposure to organic chemicals</i></p> <p><i>Approved for Zone 1/21 and Zone 2/22 areas.</i></p> <p><i>See data sheet for full details.</i></p>	<p>120 Vac</p> <p>10 W/m</p> <p>15 W/m</p> <p>30 W/m</p> <p>45 W/m</p> <p>60 W/m</p>	<p><i>Catalog No.:</i></p> <p>3MSB1-CT</p> <p>5MSB1-CT</p> <p>10MSB1-CT</p> <p>15MSB1-CT</p> <p>20MSB1-CT</p>	<p><i>Order No.:</i></p> <p>439509</p> <p>439510</p> <p>439511</p> <p>439512</p> <p>439513</p>	<p><i>Part No.:</i></p> <p>07-5854-110F</p> <p>07-5854-115F</p> <p>07-5854-130F</p> <p>07-5854-145F</p> <p>07-5854-160F</p>
				<p>230 Vac</p> <p>10 W/m</p> <p>15 W/m</p> <p>30 W/m</p> <p>45 W/m</p> <p>60 W/m</p>	<p><i>Catalog No.:</i></p> <p>3MSB2-CT</p> <p>5MSB2-CT</p> <p>10MSB2-CT</p> <p>15MSB2-CT</p> <p>20MSB2-CT</p>	<p><i>Order No.:</i></p> <p>439514</p> <p>439515</p> <p>439516</p> <p>439517</p> <p>439518</p>	<p><i>Part No.:</i></p> <p>07-5854-710F</p> <p>07-5854-715F</p> <p>07-5854-730F</p> <p>07-5854-745F</p> <p>07-5854-760F</p>

Power connection, splice and junction components

	<p>PBS-200-E/E10 Single power entry connection kit "on pipe"</p> <p>For connection of a trace heater inside a junction box. Includes a mounting stand for on-pipe installation and a silicone end seal.</p> <p>Maximum power conductor size: PBS-200-E 6 mm² PBS-200-E10 10 mm²</p> <p>2 pipe straps per stand required. For a complete list of kit contents and approvals see data sheet.</p>	<p><i>PBS-200-E:</i> Catalog No.: PBS-200-E Part No.: 27-54P2-42221B10</p> <p><i>PBS-200-E10:</i> Catalog No.: PBS-200-E10 Part No.: 27-54P2-43223B10</p>
---	--	---

	<p>PBS-300-E/E10 Single power entry connection kit "off pipe"</p> <p>For connection of a trace heater inside a junction box. Includes a mounting stand for off-pipe installation and a silicone end seal.</p> <p>Maximum power conductor size: PBS-300-E 6 mm² PBS-300-E10 10 mm²</p> <p>2 pipe straps per stand required. For a complete list of kit contents and approvals see data sheet.</p>	<p><i>PBS-300-E:</i> Catalog No.: PBS-300-E Part No.: 27-54P2-42111B10</p> <p><i>PBS-300-E10:</i> Catalog No.: PBS-300-E10 Part No.: 27-54P2-43113B10</p>
---	--	---

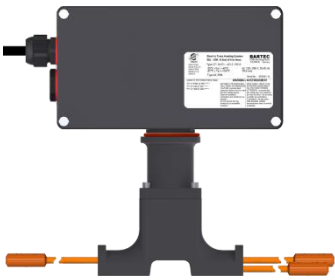
	<p>PBM-200-E/E10 Multiple power entry connection kit "on pipe"</p> <p>For connection of up to 3 trace heaters inside a junction box. Includes a mounting stand for on-pipe installation and 2 silicone end seals.</p> <p>Maximum power conductor size: PBM-200-E 6 mm² PBM-200-E10 10 mm²</p> <p>2 pipe straps per stand required. For a complete list of kit contents and approvals see data sheet.</p>	<p><i>PBM-200-E:</i> Catalog No.: PBM-200-E Part No.: 27-54P2-44331B10</p> <p><i>PBM-200-E10:</i> Catalog No.: PBM-200-E10 Part No.: 27-54P2-45333B10</p>
---	--	---

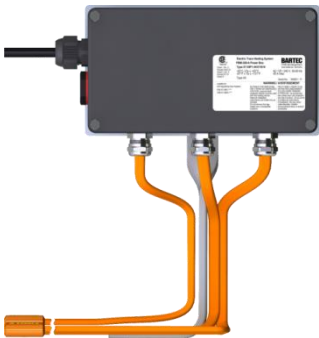
	<p>PBM-300-E/E10 Multiple power entry connection kit "off pipe"</p> <p>For connection of up to 3 trace heaters inside a junction box. Includes a mounting stand for off-pipe installation and 2 silicone end seals.</p> <p>Maximum power conductor size: PBM-300-E 6 mm² PBM-300-E10 10 mm²</p> <p>2 pipe straps per stand required. For a complete list of kit contents and approvals see data sheet.</p>	<p><i>PBM-300-E:</i> Catalog No.: PBM-300-E Part No.: 27-54P2-44311B10</p> <p><i>PBM-300-E10:</i> Catalog No.: PBM-300-E10 Part No.: 27-54P2-45313B10</p>
---	--	---



PLEXO-TCS Low profile in-line splice

In-line splice kit for connections below the insulation and cladding. The kit is re-enterable for ease of maintenance at pumps and vessels. The kit is approved for Zone 1 and Zone 2 areas.

For a complete list of kit contents, approvals and additional configurations see data sheet.

Catalog No.: PLEXO-TCS
Part No.: 27-59P2-0110

Control and monitoring units

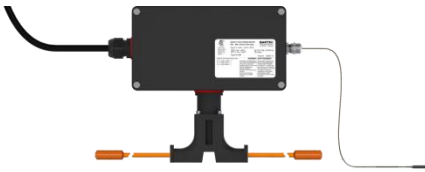

PBTW Mechanical thermostat for hazardous locations (on-pipe installation)

Select this thermostat when the control unit is located in a hazardous location, ruggedness is important and the control device is integrated with the power connection and can be mounted on the pipe.

For a complete list of temperature range options, kit contents and approvals see datasheet.

Sensor temperature range -20 °C to 50 °C:

Catalog No.: PBTW-200-E050

Part No.: 27-54D2-4422/C210

Catalog No.: PBTW-300-E050

Part No.: 27-54D2-4411/C210

Sensor temperature range 0 °C to 190 °C:

Catalog No.: PBTW-200-E190

Part No.: 27-54D2-4422/D210

Catalog No.: PBTW-300-E190

Part No.: 27-54D2-4411/D210

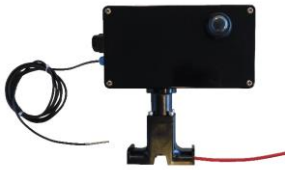

PBTC Electronic thermostat for hazardous locations

Select this thermostat when the control unit is located in a hazardous location, as an adjustable electronic control thermostat. It is integrated an LED status indication and also the power connection and can be mounted on the pipe.

For a complete list of temperature range options, kit contents and approvals see datasheet.

Sensor temperature range -50 °C to 200 °C:

Catalog No.: PBTC-200-E

Part No.: 27-54C2-4412/E210

Catalog No.: PBTC-300-E

Part No.: 27-54C2-4411/E210



ESTM-30 Electronic thermostat for hazardous locations

Select this thermostat when the control unit is located in a hazardous location, as an adjustable electronic control thermostat. It is integrated monitoring technology, diagnostics and communications interface, Modbus RTU and Bluetooth communication.

For a complete list of temperature range options, kit contents and approvals see datasheet.

Sensor temperature range -70 °C to 500 °C:

Catalog No.: ESTM-30-E

Part No.: 17-88C1-F22H/1R10

End termination

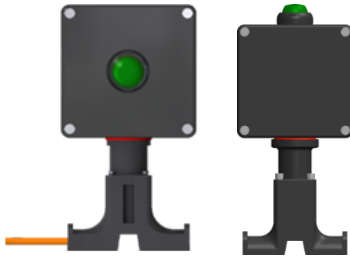

ELL-200 End of line lamp

End of line lamp for connection of a trace heater. Includes a mounting stand for on-pipe installation. The kit is approved for Zone 1 and Zone 2 areas.

*2 pipe straps per stand required.
For a complete list of kit contents and approvals see data sheet.*

Catalog No.: ELL-200-E
Part No.: 27-54E2-4212/F210
Option top light available on request.

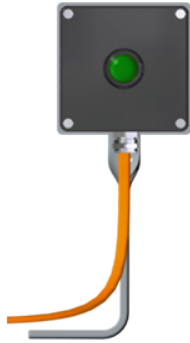

ELL-300 End of line lamp

End of line lamp for connection of a trace heater. Includes a mounting stand for off-pipe installation. The kit is approved for Zone 1 and Zone 2 areas.

*2 pipe straps per stand required.
For a complete list of kit contents and approvals see data sheet.*

Catalog No.: ELL-300-E
Part No.: 27-54E2-4211/F210



CAK-E5/E10 Cold applied end seal

Silicone end seal for insulation of the end of the trace heater. Suitable to all Bartec parallel trace heating cable. Approved accordingly IECEx, ATEX, CSA (ordinary and hazardous locations)

CAK-E5 5 pcs.
CAK-E10 10 pcs.

CAK-E5:
Catalog No.: CAK-E5
Part No.: 27-59CZ-90000005
CAK-E10:
Catalog No.: CAK-E10
Part No.: 27-59CZ-90000010



ELS-200 high profile end seal

End seal for access above the insulation.

*2 pipe straps per mounting stand required.
For a complete list of kit contents and approvals see data sheet.*

Catalog No.: ELS-200
Part No.: 27-54E2-AA12A000



Plexo TCS end seal

Plug-in end seal for easy connection of trace heaters

Catalog No.: PLEXO-TCS
Part No.: 27-59P3-0010

Spare parts

	<p>On pipe cable gland kit and end seal</p> <p>Spare parts kit for use with heating cable PSB, MSB, HSB+, HTSB for replacement of damaged or lost parts.</p>	<p>Catalog No.: CAK-SRS Part No.: 27-59CX-9C01/0001</p> <p>Multi-kits available on request.</p>
--	---	---

	<p>Off pipe cable gland kit and end seal</p> <p>Spare parts kit for replacement of damaged or lost parts.</p> <p><i>CAK-SRG with cable gland TG-*-1 for use with heating cable PSB, MSB</i></p>	<p>Catalog No.: CAK-SRG with TG-*-1 Part No.: 27-59CX-7301/0001</p> <p>Other sets available on request.</p>
--	--	---

	<p>Off pipe cable gland kit and end seal</p> <p><i>CAK-SRG-B with cable gland FG-S-1 for use with heating cable PSB, MSB, HSB+, HTSB</i></p> <p><i>CAK-SRG-C with cable gland FG-S-C for use with heating cable PSB, MSB, HSB+, HTSB; cable gland provides adaptor to Conduit system</i></p>	<p>Catalog No.: CAK-SRG-B with FG-S-1 Part No.: 27-59CX-97010001</p> <p>Catalog No.: CAK-SRG-C with FG-S-C Part No.: 27-59CX-93010001FGSC</p> <p>Other sets available on request.</p>
--	---	---

	<p>Splice adaptor kit</p> <p>For above the insulation splice kit.</p> <p><i>CAK-M25 suitable for: PBS/PBM-*-E, provides M25x1.5 entry</i></p> <p><i>CAK-M32 suitable for: PBS/PBM-*-E10, provides M32x1.5 entry; PBS/PBM-*-E16, provides M32x1.5 entry</i></p>	<p>Catalog No.: CAK-M25 Part No.: 27-59CX-0G01/0001</p> <p>Catalog No.: CAK-M32 Part No.: 27-59CX-0H01/0001</p>
--	---	---

Installation self-regulating trace heaters on pipes and vessels

Preparation

Before installing any electric trace heating, the person installing must check if the trace heating has been designed and planned correctly. It is particularly essential to verify the following points:

- complete project planning documentation, operating instructions and installation instructions.
- correct selection of the trace heater and accessories with respect to:
 - calculation of heat losses
 - max. permissible operating temperature
 - max. permissible ambient temperature
 - temperature class
 - heating circuit length

Before installing, make sure that all piping and equipment is properly installed and pressure tested.

Required tools / equipment

The following tools are required for installation of the BARTEC Self-regulating trace heating systems:

- Wire cutters
- Insulation resistance meter with a minimum test voltage of 500 Vdc. BARTEC strongly recommends a test device with a test voltage of 1000 Vdc and 2500 Vdc.



2

Installation on pipes

This step is necessary for plastic pipes only since plastic pipes conduct heat loss efficiently than metal pipes do. For metal pipes refer to step 4.

- Place aluminium tape where the trace heater will be attached for better heat distribution.



3

Unrolling the trace heater

⚠ WARNING

Risk of short circuit and/or material damage. Keep the trace heater ends dry before and during installation.

- Unroll the required trace heater in a straight line and cut to the correct length. Cut off the trace heater ensuring a straight cut.
- Do not bend or pinch the trace heater, or pull it over sharp edges.

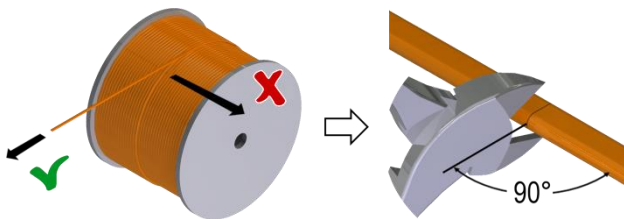

1

⚠ CAUTION

Risk of injury and/or material damage. Never step on or drive over the trace heater. Do not use it as a loop for stepping on.

- Install the trace heater in a straight line along the pipe. This saves time, helps to avoid installation mistakes and prevents damage to the trace heater during the thermal insulation work.



4

- Preferably install the trace heater in the lower half of the pipe, **but not on the lowest point**. This prevents mechanical damage and allows for better heat distribution.
- If you use multiple trace heaters, position them with an offset of 90°.

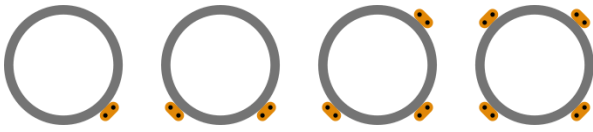

- Mount the mounting stand and junction box preferably on top of the workpiece, e.g. the pipe. If a different orientation of the junction box and mounting stand is necessary, there is a risk of water collecting in the mounting stand.

Avoid water accumulation in the mounting stand!

BARTEC recommends applying the pipe insulation immediately after installing the junction box and the mounting stand.

5

- Apply the pipe's insulation according to the manufacturer's installation instructions.
- Apply an electrical warning label every 3 m on a clearly visible place.

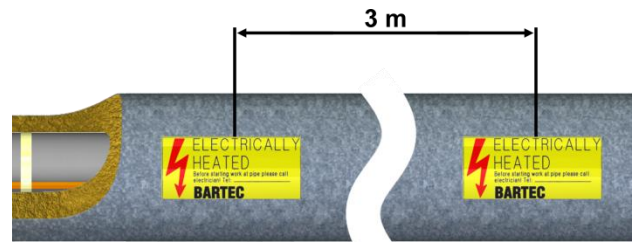

8

Fastening

Select the correct fastening material:

- Use polyester adhesive tape or glass cloth tape that suits the expected temperatures.
- Preferably use BARTEC adhesive tapes.
- Never use PVC electrical tape or self-adhesive tapes containing PVC or VC.
- Do not use metal wire or banding.



6

- Fasten the trace heater with the adhesive tape at intervals of max. 300 mm on plastic pipes or 900 mm on steel pipes.

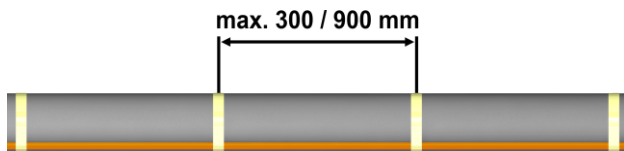

NOTICE

In order to ensure good heat transmission the trace heater must have a flat, flush fit over the whole length. If necessary, reduce the distances between the fixing points.

7

Trace heater routing

- On fittings, valves etc. you should leave a sufficiently large trace heater loop to ensure that the equipment is easily accessible. This way, heating circuits do not have to be cut up for maintenance or replacement works.
- Due to the higher heat losses from fittings, valves, flanges etc. an additional length of trace heater is required. This requirement is specified in the project planning documents.
- The following illustrations show typical types of installation.

NOTICE

The bending radius of the trace heater must always be at least 25 mm. Do not bend on the narrow axis.

9

- Installation on bends:

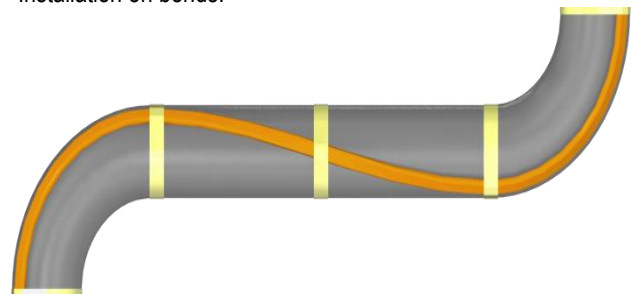

10

- Installation of service loops on components:



11

- Installation on flanges:

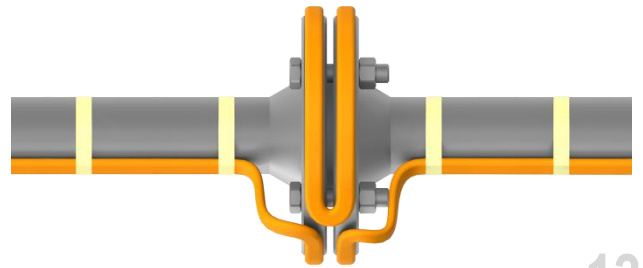
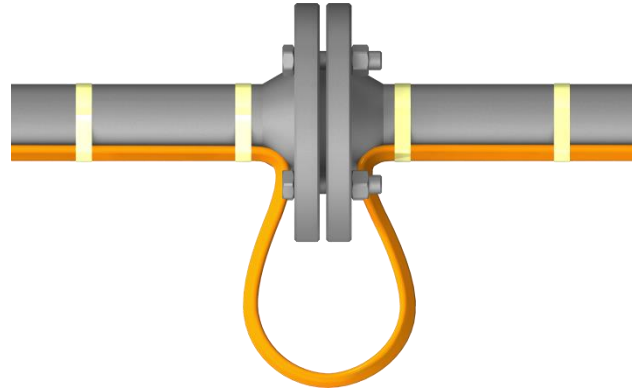

13

- Installation on valves:

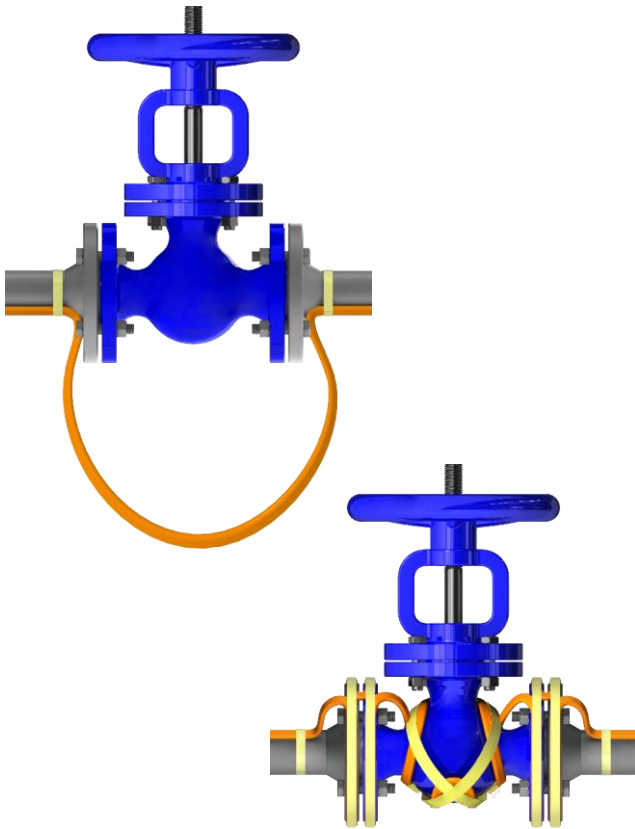

12

- Installation on pipe supports:

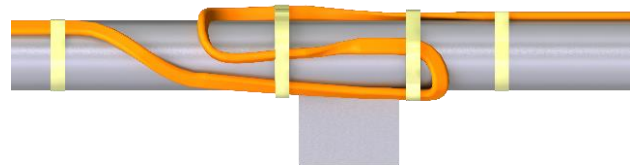

14

- Installation on pressure gauges:



15

- Installation on pumps:

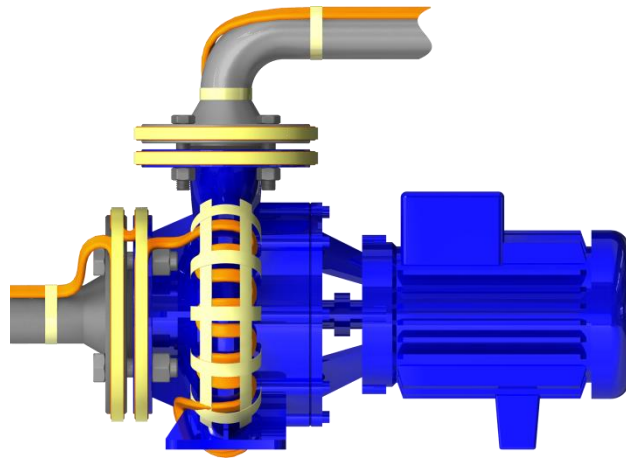

16

Installation on tanks and vessels

- For tank diameters of up to 2 m the trace heater is attached using polyester fixing straps and tensioning buckles.

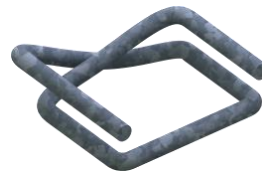

- To fasten the fixing straps thread the polyester straps through the tensioning buckle as shown and pull the ends of the straps.

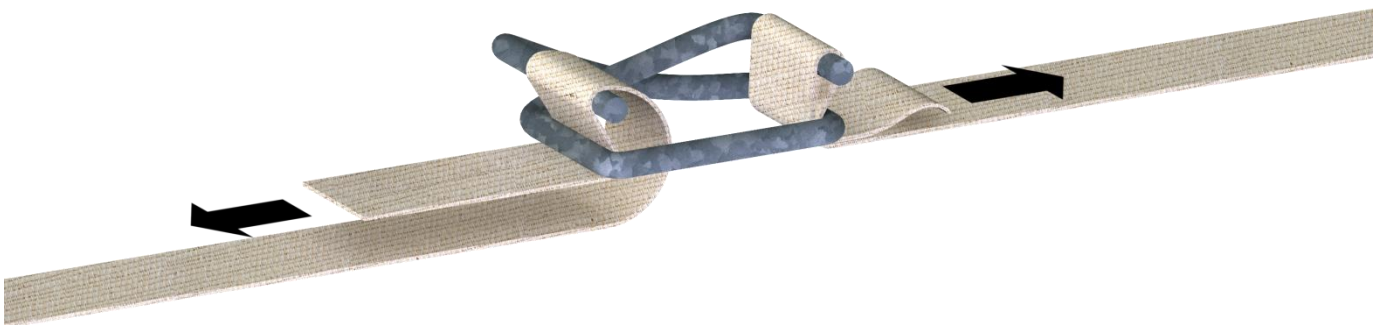

17

- At first, install fixing straps around the beginning and end of the tank and fasten them with slight tension.

Upright tank



Horizontal tank

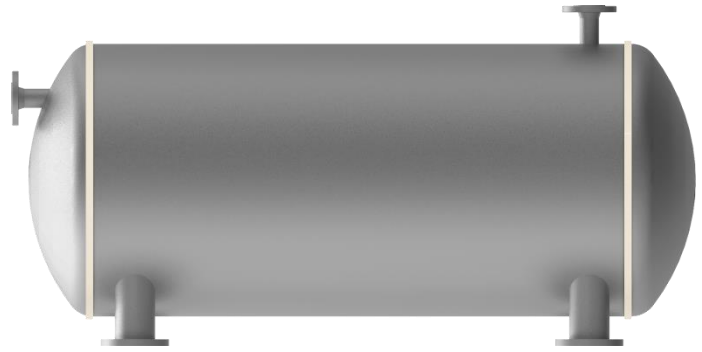

18

- Install the trace heater beginning at the supply point.
- Fix it at the distances specified in the project planning documentation. Use the pre-mounted fixing straps to hold the trace heaters in place.
- Allow for material addition for the bases.

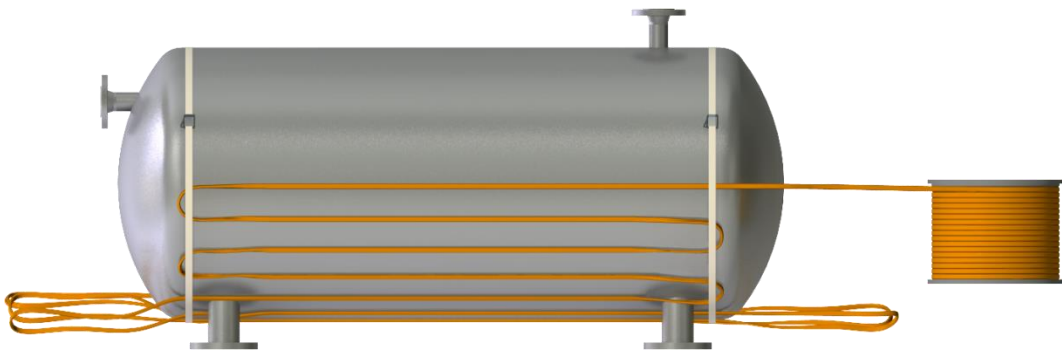

19

- Align the trace heater exactly and fix it firmly to the bases and the cylinder using additional fixing straps.
- To avoid damage to the trace heater, make sure that the fixing straps are not tightened too firmly. It should be possible to move the trace heater slightly under the fixing straps.
- The distances between the fixing straps should not exceed 250 mm.

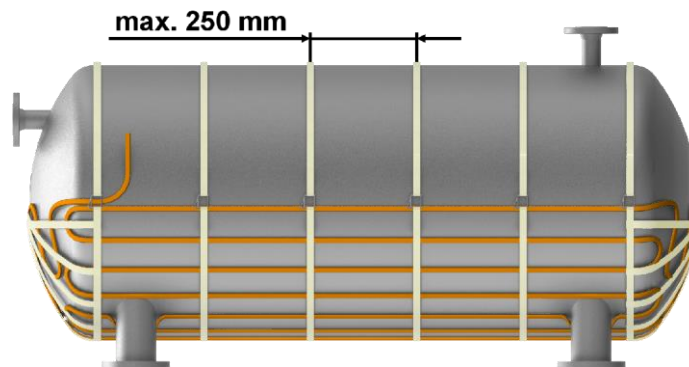

20

- Finally, place aluminium tape on areas of loose contact of the trace heater.
- This step improves heat transfer and prevents insulating material being trapped between the trace heater and the tank.

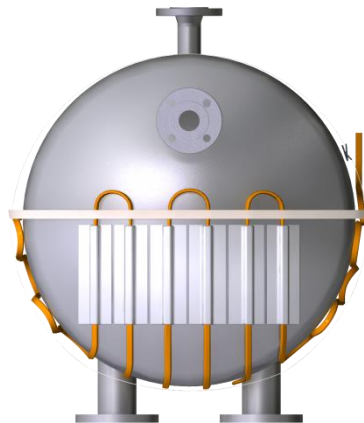

21

Tests and commissioning

Measurement of the insulation resistance

The measurement of the insulation resistance is used to determine damage to the trace heater and possible installation faults. It must be carried out at the following times:

- Preliminary test (on the reel, before installation of the trace heater on the construction site; refer to section *Acceptance Report* on page 40)
- Acceptance test (after installation of the heating circuit and before installation of the thermal insulation; refer to section *Acceptance Report* on page 40)
- Final inspection (immediately after completion of work on the thermal insulation)
- Upon commissioning
- Before switching on the installation

Preparation of the measurement:

- De-energize the heating circuit.
- Disconnect the thermostat or controller, if installed.
- Disconnect the bus wires and PE wires from the terminal block, if installed.
- For the measurement you need an Insulation resistance meter with minimum test voltage 500 Vdc. BARTEC strongly recommend a higher test voltage of 1000 Vdc and 2500 Vdc. Installation faults can be detected more reliably with a test voltage of 1000 Vdc and 2500 Vdc.

Test 1 - Conducting the measurement between the bus wires and the grounding braid:

- Set the test voltage to 0 Vdc.
- Connect the negative (-) lead to the grounding braid of the trace heater.
- Connect the positive (+) lead to both trace heater bus wires simultaneously.
- Turn on the megohmmeter and set the voltage to 500 Vdc.
- Apply the voltage for 1 minute. The meter reading should stabilize. Rapid changes in the reading indicate a breakdown of the insulation.
- Record the insulation resistance value in the Inspection Record.
- Repeat the measurement at 1000 Vdc and 2500 Vdc strongly recommended.

Test 2 - Conducting the measurement between the grounding braid and PE:

- Repeat the measurement between the grounding braid and PE again (at 500 Vdc, 1000 Vdc and 2500 Vdc strongly recommended).

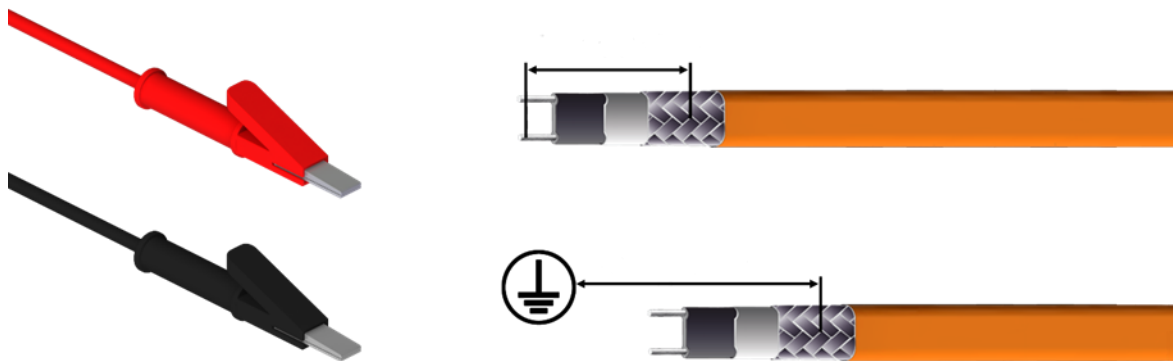

Results:

- Properly installed dry and clean trace heater sets should measure thousands of megohms, regardless of the trace heater length or measuring voltage (500 Vdc - 2500 Vdc). Even if optimum conditions may not apply, all insulation resistance values should be greater than the IEC 60079-30-2:2015 minimum recommendation of 20 megohms. However, BARTEC strongly recommends a minimum reading of 1000 megohms. If the reading is lower or fluctuating, refer to section *Troubleshooting* on page 41.
- Insulation resistance values for Test 1 and 2; for any particular circuit, should not vary more than 25 percent as a function of measuring voltage. Greater variances may indicate a problem with your trace heating system; confirm proper installation and/or contact your local BARTEC representative for assistance.

⚠ WARNING
 Risk of fire or electrical shock. If the insulation resistance is insufficient you must fix the heating circuit before putting it into operation.

After the measurement:

- If trace heater meets all resistance criteria:
- Reconnect the bus wires and PE wires to the terminal block.
 - Reconnect any thermostat or controller.
 - Reenergize the circuit.

Acceptance test and acceptance test report

- After completion of the installation work (before installation of the thermal insulation) each heating circuit must be accepted, if possible in the presence of the client.
- All further tests must also be documented in an acceptance test report (refer to section *Acceptance report / Record of inspection* on page 40).

NOTICE

Claims under warranty will not be considered if the acceptance report is not filled in completely.

- After completion of work on the thermal insulation final inspection and acceptance of the individual heating circuits is recommended. Usually, this is the task of the client or the final customer (= final inspection).

Commissioning

Each heat tracing system can only be put into operation if the following conditions are fulfilled:

- The acceptance test reports for each heating circuit are complete and the trace heating system has been accepted.
- All components of the heating circuit are completely installed and are in working order.
- It has been ensured that the heating circuit is operated in conformance with the technical data specified by BARTEC.
- It has been ensured that the trace heating system parameters (as indicated in design documentation) will be verified during commissioning.

NOTICE

Upon a cold start, additional heating power is required for heating up tanks and pipes. When starting the system you should allow sufficient time for heat up. For further information on heat up calculations contact your local BARTEC representative.

Operation

During operation of the electric trace heating system you must ensure that all components of the system are operated within the operating data specified by BARTEC.

This applies particularly to observation of the maximum temperature. Operation within these operating data is a precondition for possible later warranty claims.

System documentation

Complete documentation must be carried out for each system, from the project planning stage, through installation and commissioning up to periodic maintenance of the trace heating system.

This documentation should include the following:

- Project planning documents
- Results of design calculation e.g. summarized in Print out of Heloc Pro calculation or Manual calculation documented e.g. in BARTEC template 21-1000-7E0001 (www.bartec.com) In detail:
 - Trace heating circuit identification
 - Pipe size or workpiece dimensions
 - Maximum ambient temperature
 - Maximum workpiece temperature
 - Temperature to be maintained or the maximum process/exposure temperature
 - Thermal insulation type/size and thickness
 - Thermal insulation cladding if applicable
 - Heat loss calculation
 - Selection of trace heater type
 - Operating voltage
 - Temperature class or maximum sheath temperature
 - Layout plans with sections of heating circuits
 - Trace ratio
 - Circuit graphs (e.g. Circuit diagram or single line diagram)
- Manuals of all of the components of the heating system
- Acceptance reports
- Reports on repairwork and any operations carried out on the tank/pipe system, trace heating system and thermal insulation
- Inspection reports

Maintenance

Visual and functional inspection

- Regularly check the thermal insulation for possible damage, missing seals, cracks, damage to the outer jacket, missing thermal insulation bushings for trace heaters and cables, penetrated water or chemicals. If the thermal insulation is damaged the trace heater should be checked for possible damage.
- Damaged trace heaters must be replaced.
- Parts subject to wear must be replaced (e.g. seals, locking plates etc).
- Check junction boxes, splices, end terminations etc. for corrosion and possible mechanical damage. Make sure that all enclosure covers are properly in place.
- If present, check the temperature controller connecting cables and sensors for damage and that their installation is protected against mechanical damage.

Electrical inspection

- Measurement of the insulation resistance should be seen as a permanent part of regular maintenance. For instructions on how to perform the test refer to section *Measurement of the insulation resistance* on prior pages.
Upon completion of maintenance/repair/modification, the insulation resistance of the trace heater shall be measured and recorded after installation and shall not be less than 20 MOhm.

Inspection intervals

- For frost protection installations inspections should be carried out annually before the heating period begins.
- For systems designed to maintain process temperatures, inspections should be carried out at regular intervals, but at least twice a year.

⚠ WARNING
 Risk of serious injury due to electrostatic charging.
 For plastic type label electrostatic charging hazard exist. Only wet cleaning is allowed.

Personnel training courses

- Regular maintenance should be carried out by trained, experienced maintenance personnel.
- It is recommended that maintenance personnel is updated on new developments in application technology and maintenance.

Repairwork on piping or thermal insulation

⚠ CAUTION
 Consult the trace heating system documentation prior to maintenance/repair/modification.

- Ensure that all safety procedures and precautions in the area for repairs are followed.
- Take care that the heat tracing system is not damaged during repairwork on the pipes or insulation.
- After completion of the repairwork:
 - Make sure that any repaired heating circuits are properly installed and tested according to the project planning documentation.

⚠ WARNING
 Risk of fire or electrical shock due to damaged components. Remember that self-regulating trace heaters are designed to be installed only once.

- Carry out a visual, functional and electrical test (refer to section *Tests and commissioning* on page 36).
- Test the operation of the earth-fault device of each affected circuit" or equivalent.
- In the event of an earth fault or over current interruption, the device shall not be reset until the cause of the trip has been investigated by qualified personnel" or equivalent.

Disposal and Recycling

Each product of the heating system must be disposed of properly in accordance with legal regulations. The main components are glass-fibre reinforced plastic, metal and electrical components. Each product must be disassembled into its components and fed into the recycling system in accordance with its components.

 **Disposal**
 The appliance must be disposed of in accordance with local laws and regulations according to its components.

Checklist customized entry port

For customized power entry port or capillary tube entry, the following data are mandatory for type selection of:					
Component:		Power cable gland	Power entry blind plug	Breather device; Drain device	Capillary tube cable gland
Identification:	Manufacturer: Type:	_____ _____ _____	_____ _____ _____	_____ _____ _____	_____ _____ _____
Standards to comply:	IEC 60079-0:2017; IEC 60079-7:2017; IEC 60079-31:2013 IEC EN 60079-0:2018; EN 60079-7:2015 + A1:2018; EN 60079-31:2014	yes <input type="checkbox"/>	yes <input type="checkbox"/>	yes <input type="checkbox"/>	yes <input type="checkbox"/>
Type of protection:	Ex eb, Ex tb	yes <input type="checkbox"/>	yes <input type="checkbox"/>	yes <input type="checkbox"/>	yes <input type="checkbox"/>
Ambient temperature range:	PSB: -55 °C to +75 °C MSB: -55 °C to +70 °C Temperature ranges are also valid for earth lugs with cord.	__ °C to __ °C __ °C to __ °C yes <input type="checkbox"/>	__ °C to __ °C __ °C to __ °C yes <input type="checkbox"/>	__ °C to __ °C __ °C to __ °C yes <input type="checkbox"/>	__ °C to __ °C __ °C to __ °C yes <input type="checkbox"/>
Degree of ingress protection:	IP66 in accordance with IEC 60529 and IEC 60079-0	yes <input type="checkbox"/>	yes <input type="checkbox"/>	yes <input type="checkbox"/>	yes <input type="checkbox"/>
Grade of mechanical risk:	High (7J)	yes <input type="checkbox"/>	yes <input type="checkbox"/>	yes <input type="checkbox"/>	yes <input type="checkbox"/>
Material	metal or plastic; For nuts and gland, mounted together, the material shall be equal for keeping the Grade of mechanical risk at High (7J).	yes <input type="checkbox"/> kind of material: _____	yes <input type="checkbox"/> kind of material: _____	yes <input type="checkbox"/> kind of material: _____	yes <input type="checkbox"/> kind of material: _____
Thread size:	M20x1.5; M25x1.5; M32x1.5 also suitable for nuts	M __x1.5 yes <input type="checkbox"/>	M __x1.5 yes <input type="checkbox"/>	M __x1.5 yes <input type="checkbox"/>	M12x1 only yes <input type="checkbox"/>

For installation of selected components, the manufacturer's installation manual must be observed. Thus above mentioned advices may differ. It must be added to the junction box documentation.
It is not allowed to add or manipulate drillings and threads at the BARTEC junction box.

For selecting type of Power supply cable, see chapter Technical Data.

Remarks:

City/Date

Engineer
Name / Signature

Customer
Name / Signature

NOTICE

Claims under warranty will not be considered if the check list is not filled in completely.

Acceptance report / Record of inspection

Protocol type

Inspection before commissioning <input type="checkbox"/>	Inspection after modification <input type="checkbox"/>	Periodic inspection <input type="checkbox"/>
Visual inspection <input type="checkbox"/>	Close inspection <input type="checkbox"/>	Detailed inspection <input type="checkbox"/>

Project information

Project / Customer	
Order Comm. No. / BARTEC Order No.	
Date	

Installation details

Heating circuit type	Electric Trace Heating of Pipes <input type="checkbox"/>	Electric Trace Heating of Tanks/Vessels <input type="checkbox"/>
Ex version	yes <input type="checkbox"/> no <input type="checkbox"/> Zone <input type="text"/>	Temperature class T <input type="checkbox"/> Ex group <input type="text"/>
Switchgear / Distribution panel	Included in the scope of delivery	UV Name ESS/LDP
	yes <input type="checkbox"/> no <input type="checkbox"/>	Test report <input type="checkbox"/>
Thermal insulation	Thermal insulation material	Thermal insulation thickness in mm (inch) <input type="text"/>
	Check before installation of the insulation Date / Name / Signature	Check after installation of the insulation Date / Name / Signature

Heating circuit data

Heating Circuit No.									
Sub-Heating circuit	yes <input type="checkbox"/>	no <input type="checkbox"/>		yes <input type="checkbox"/>	no <input type="checkbox"/>		yes <input type="checkbox"/>	no <input type="checkbox"/>	
Pipe-/Vessel No.									
Building									
Product									
Trace heater type									
Lot No. of trace heater									
Trace heater length	_____ m			_____ m			_____ m		
Serial No. connection kit									
Serial No. junction box									
Voltage	_____ V			_____ V			_____ V		
Current (Switch on / operation)	_____ / _____ A			_____ / _____ A			_____ / _____ A		
Output power trace heater	_____ W/m			_____ W/m			_____ W/m		
Trace heater resistance	_____ Ω			_____ Ω			_____ Ω		
Insulation resistance at V (Test 1)	> _____ MΩ			> _____ MΩ			> _____ MΩ		
Insulation resistance at V (Test 2)	> _____ MΩ			> _____ MΩ			> _____ MΩ		
Temperature settings	°C	yes	no	°C	yes	no	°C	yes	no
Controller	_____	<input type="checkbox"/>	<input type="checkbox"/>	_____	<input type="checkbox"/>	<input type="checkbox"/>	_____	<input type="checkbox"/>	<input type="checkbox"/>
Limiter	_____	<input type="checkbox"/>	<input type="checkbox"/>	_____	<input type="checkbox"/>	<input type="checkbox"/>	_____	<input type="checkbox"/>	<input type="checkbox"/>
Low temperature	_____	<input type="checkbox"/>	<input type="checkbox"/>	_____	<input type="checkbox"/>	<input type="checkbox"/>	_____	<input type="checkbox"/>	<input type="checkbox"/>

Remarks:

City/Date

BARTEC Contractor
Name / Signature

Customer
Name / Signature

NOTICE

Claims under warranty will not be considered if the acceptance report is not filled in completely.

Troubleshooting

Problem	Possible cause	Remedy
Trace heater remains cold	No power supply	Check the power wiring for continuity to circuit breaker.
	Trace heater bus wires or power wiring not properly connected	Connect the trace heater and power wiring according to the installation instructions.
	Control unit adjusted incorrectly	Adjust the control unit according to the installation instructions.
Automatic circuit breaker tripped	Automatic circuit breaker defective	Replace the automatic circuit breaker.
	Automatic circuit breaker has wrong tripping characteristics, e. g. "B" instead of "C"	Install an automatic circuit breaker with Type-C tripping characteristics or contact the factory for Type-B tripping characteristics.
	Nominal circuit breaker size is insufficient	Install an automatic circuit breaker with higher capacity. Observe the maximum amperage of all components of the trace heating circuit!
	Maximum heating circuit length has been exceeded	Split the heating circuit into separate circuits.
	End seal has not been installed	Install the end seal according to the installation instructions.
	Short circuit	Identify the cause and remedy the fault (e. g. ensure that trace heater bus wires are not twisted together).
Ground fault protection is disengaged	Trace heater damaged	Replace the trace heater at the point where it is damaged.
	Moisture in the components	Dry the components. For junction boxes, be sure that the cable gland is correctly installed and sealing properly.
	Ground fault protection defective	Replace the ground fault protection device(s).
Low or inconsistent insulation resistance	Trace heater damaged	Replace the trace heater at the point where it is damaged.
	Moisture in the components	Dry the components. For junction boxes, be sure that the cable gland is correctly installed and sealing properly.
	Arcing due to damaged trace heater insulation	Replace the trace heater at the point where it is damaged.
	Arcing due to inadequate stripping distance between heating element and grounding braid	Check the stripping distance between bus wires/heating element and grounding braid at all power, splice and end seal connections to ensure adequate separation.
	Short-circuit between the grounding braid and the heating element or the grounding braid and the pipe	Check for cut or damaged cable or inadequate stripping length.
	Test leads touching the junction box	Relocate test leads and retest.

Note: High pipe temperature may lower the insulation resistance reading relative to earlier readings on a cold pipe.

Limited Product warranty (Worldwide, excepting North America)**Scope**

BARTEC warrants that all BARTEC products and accessories that are the subject of this manual will be free from defects in materials and workmanship from and after its date of purchase for a period of 12 (twelve) months.

For the avoidance of doubt, this limited product warranty will **not** cover any damage caused by:

- accidents,
- misuse, improper installation, operation, maintenance or repairs,
- neglect, or
- alteration.

Furthermore, BARTEC cannot be held liable under this warranty for:

- installation or removal costs,
- loss or damage to property,
- indirect, special, incidental or consequential damages (including, without limitation, loss of revenue or anticipated profits), or
- any other damages or costs directly or indirectly related to the warranty issue.

If all warranty conditions are met (as set forth below), BARTEC will, at its sole discretion:

- repair the product,
- replace the product, or
- refund the purchase price paid for the product.
- This warranty gives you specific legal rights, and you may also have other rights which vary by country, state or province. Except as specifically provided otherwise in this limited product warranty, the BARTEC Group General Terms and Conditions shall apply.

General terms and conditions

BARTEC Global Terms and conditions are available at: <https://www.bartec.de/en/terms/>

Conditions

- The limited product warranty is subject to the following conditions:
- proper installation, operation and maintenance in compliance with the state of the technology and the product documentation, and
- presence of completely filled in acceptance reports for all installation, maintenance and repairwork operations.

How to claim the warranty

To file a claim under the limited product warranty:

- Notify BARTEC or your local BARTEC representative by written correspondence or email within 30 days after identification of a possible warranty issue.
- If requested, you must provide any warranty-related information and documentation to BARTEC, including, without limitation:
 - project planning documents, and
 - acceptance reports for installation, operation, maintenance or repairwork.

Contact

Bartec GmbH, Max-Eyth-Strasse 16, 97980 Bad Mergentheim

Phone: +49 7931 597-0

Fax: +49 7931 591-499

info@bartec.com

